

The Little Book of Profiling

**Basic Information about Measuring and Interpreting
Road Profiles**

September 1998

**Michael W. Sayers
Steven M. Karamihas**

**© Copyright 1998 The Regent of the University of Michigan
All Rights Reserved**

Contents

Introduction	1
What Is a Profile?	2
What Is a Profiler?	3
What Can You Do With Profiles?	9
What is a Valid Profiler?.....	10
When Is a Profiler Not Valid?	12
What Is Signal Processing?	12
What Is Sample Interval?.....	13
What Is Filtering?	16
What Is a Moving Average?.....	18
What Are Sinusoids?.....	21
What Is Frequency Response?.....	23
What Is a Power Spectral Density?.....	26
What is Vehicle Ride?.....	30
How Is Vertical Acceleration Related to Profile?	32
How Does Ride Relate to the Road?	35
What Is Road Roughness?	37
What Are Response-Type Systems?	39
What Are the Frequency Responses of Roughness Measuring Devices?.....	41
What Is a Profile Index?.....	43
What Is the IRI?	45
What Are Panel Ratings?	52
What Is Ride Number?	55
What Other Roughness Indices Are In Use?.....	60
What Is the Effect of Length?.....	67
What Is Verification Testing?	70
What Is Calibration?	72
What Is Correlation?	73
What Are Errors?.....	79
What Causes Profiling Error?.....	81
What Is The Effect of Speed?.....	86
What Is the Effect of Texture?	90
What About Cracks?	92
How Accurate Should a Profile Be?	94
What Is a Class 1 Profiler?.....	96
Bibliography	98

Introduction

High-speed road profiling is a technology that began in the 1960's when Elson Spangler and William Kelly developed the inertial profilometer at the General Motors Research Laboratory. Some users still call high-speed profilers by their early name: GMR Profilometers.

In the past decade, profiling instruments have become the everyday tools for measuring road roughness. The majority of States now own road profilers. A substantial body of knowledge exists for the field of profiler design and technology. There are also many proven methods for analyzing and interpreting data similar to the measures obtained from profilers. However, there has not been a single source of information about what you can do with a profiler. Users have instructions provided by the manufacturers to operate the equipment, but little else to go on.

Road profiler users from different States met in 1989 and formed the Road Profiler User Group (RPUG). RPUG has been meeting annually since then to provide a forum for issues involving the measurement and interpretation of road profiles. From 1992 to 1995, the authors conducted a research project at The University of Michigan Transportation Research Institute (UMTRI) called "Interpretation of Road Roughness Profile Data." The research was funded by the Federal Highway Administration (FHWA) and pooled State funds. At the 1994 RPUG meeting, representatives of the participating States suggested that a short course is needed to provide the necessary education. Dave Huft, inventor of the South Dakota profiler, proposed a "Little Golden Book of Profiling" in the spirit of the popular children's books.

The National Highway Institute (NHI) of FHWA provided funding for the authors to prepare a short course called "Measuring and Interpreting Road Profiles." The first session of the course was held in November 1995 in Ann Arbor, Michigan. The Little Book was written for the course. The book was revised and extended in September 1996 for the second session of the course, scheduled to coincide with the 1996 RPUG meeting in Denver. A third session was held in October 1997 in Overland Park, Kansas, in conjunction with the 1997 RPUG meeting.

In The Little Book, we try to cover three basic questions:

1. How do profilers work?
2. What can you do with their measurements?
3. What can you do to reduce errors?

The material is targeted at users. Our intent is make the material no more technical than is needed to describe what the measures mean that you can get from a profiler.

What Is a Profile?

☞ **A profile is a two-dimensional slice of the road surface, taken along an imaginary line.**

Profiles taken along a lateral line show the superelevation and crown of the road design, plus rutting and other distress. Longitudinal profiles show the design grade, roughness, and texture. In this book, we will focus on longitudinal profiles.

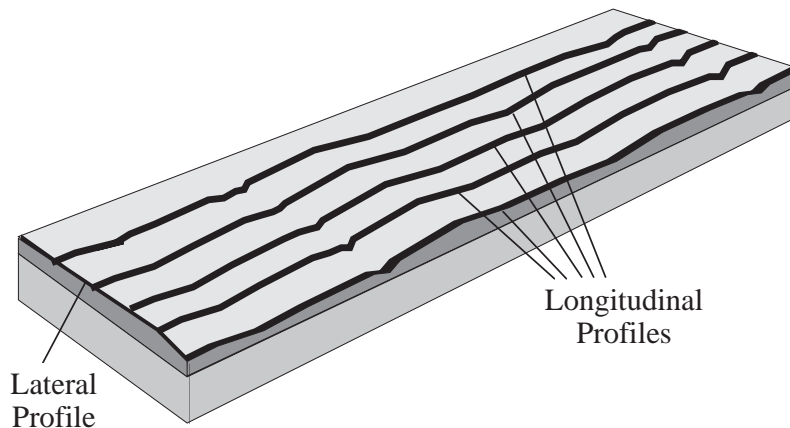

A profile of a road, pavement, or ground can be measured along any continuous imaginary line on the surface. If a measurement is repeated, the same profile can only be expected if the same imaginary line is followed. (To obtain repeatable measures, it helps to make the line less imaginary by using paint or tape to mark it physically.)

☞ **You can take many profiles for a road, each along different a line.**

It is possible to measure the profile for a curved line. Normally, the expectation for a road is that the line is a constant distance from the centerline or some other reference that follows the road geometry. Frequently, profile is measured along two lines per lane, one in each wheeltrack. For greater detail any number of lines can be measured.

☞ **The width of the line is not standard.**

The width is usually defined by the type of instrument used. For example, measures made with a laser system may cover a slice of the road just a few millimeters thick, while measures made with an ultrasonic system may cover a thicker slice of several centimeters. The effect of profile width is not yet understood. However, it is harder to exactly repeat a profile measure if the line for the profile is very thin.

☞ **For any line on the road, there is a “true profile.”**

The concept of a profile is easy to visualize. It is easy to see that for a line drawn on a physical surface, a “true profile” exists. However, the requirements for measuring the profile depend on what we want to do with the data. For example, consider two completely different uses of profile. First, suppose a new bridge is going to be built. The designer might want the profile of the road on either side of the bridge site. The profile would be adequately described with elevation points taken at 3-m intervals, for several hundred meters, with the individual measures having a resolution of a few millimeters. Now, for a second application, consider a computer analysis to characterize texture based on measured profile. The analysis requires profile points spaced 1.0 mm (0.04 in) apart, over a distance of 1 meter, with a resolution of 0.1 mm (0.004 in). Both sets of numbers are part of the “true profile” for a line on the road.

What Is a Profiler?

Instruments and test methods are used to produce a sequence of numbers related to the “true profile” for an imaginary line on the road.

☞ **A profiler is an instrument used to produce a series of numbers related in a well-defined way to a true profile.**

We will soon see that the numbers obtained from some profilers are not necessarily equal to true elevation. A profiler does not always measure true profile, exactly. It measures the components of true profile that are needed for a specific purpose. However, the relationship between the true profile and the numbers produced by a profiler must meet a specification that will be given shortly.

☞ **A profiler works by combining three ingredients.**

They are:

1. a reference elevation,
2. a height relative to the reference, and
3. longitudinal distance.

These three ingredients are combined in different ways, based on the design of the profiler. Let’s look briefly at three types of devices.

Rod and Level

The rod and level are familiar surveying tools. The level provides the elevation reference, the readings from the rod provide the height relative to the reference, and a tape measure locates the individual elevation measures.

- ☞ **The rod and level method is called “static” because the instruments are not moving when the elevation measures are taken.**

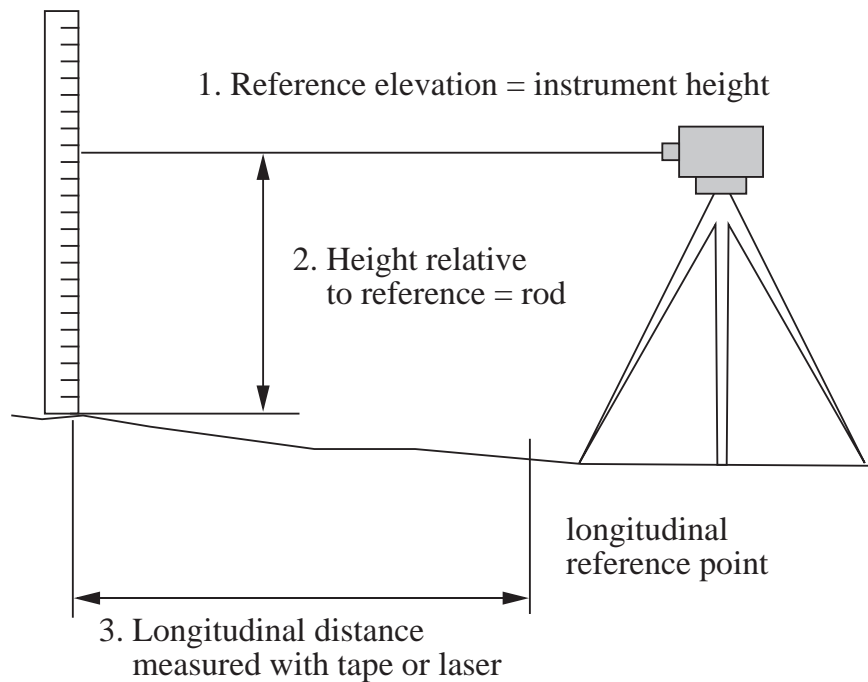

Although rod and level equipment is familiar to most engineers, the requirements for obtaining a profile measure that is valid for computing roughness are much different than for laying out a road. You must take elevation measures at close intervals of a foot or less. The individual height measures must be accurate to 0.5 mm (0.02 in) or less. These requirements are much more stringent than is normal for surveying. However, the absolute height of the instrument is not of interest when measuring profile for roughness, even though it is normally a matter of great concern when using rod and level for other applications.

- ☞ **ASTM Standard E1364 provides guidelines for measuring profiles with a static method.**

Dipstick

The Dipstick™ is a device developed, patented, and sold by the Face Company. It is faster than rod and level for measuring profiles suited for roughness analysis, and includes a battery-powered on-board computer to automatically record data and perform the arithmetic needed to produce a profile.

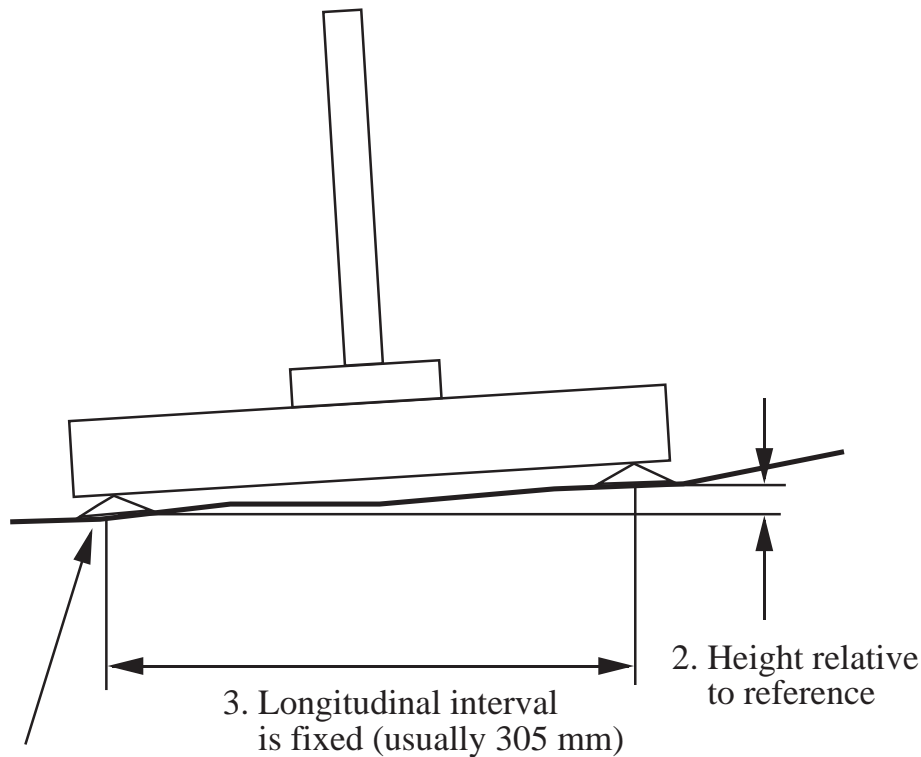

1. Previous point defines reference elevation and reference longitudinal position

The device is “walked” along the line being profiled. It contains a precision inclinometer that measures the difference in height between the two supports, normally spaced 305 mm apart. To profile a line along the ground, you lean the device so all of its weight is on the leading foot, raising the rear foot slightly off the ground. Then you pivot the device 180° about the leading foot, locating the other foot (formerly behind) in front, along the line being profiled. The computer monitors the sensor continuously. When it senses the instrument has stabilized, it automatically records the change in elevation and beeps, signaling that the next step can be taken.

With this design, the reference elevation is the value calculated for the previous point. The height relative to reference is deduced by the angle of the device relative to gravity, together with the spacing between its supports. The longitudinal distance is determined by multiplying the number of measures made with the known spacing.

☞ Instructions for using a Dipstick are provided by the manufacturer.

Profiles obtained with a Dipstick typically correspond closely to those obtained with rod and level, if you set the value of the first elevation (the initial reference) to match the elevation used in the rod and level profile.

Inertial Profiler (GM Design)

In the 1960's, a breakthrough in design made high-speed profiling possible for monitoring large road networks. This was when General Motors Research Laboratories developed the inertial profiler. Measurements from the inertial profiler combine the same three ingredients as the static rod and level and the Dipstick.

☞ The inertial reference is provided by an accelerometer.

An accelerometer is a sensor that measures acceleration. Data processing algorithms convert the vertical acceleration measure to an inertial reference that defines the instant height of the accelerometer in the host vehicle. The height of the ground relative to the reference is therefore the distance between the accelerometer (in the vehicle) and the ground directly under the accelerometer. This height is measured with a non-contacting sensor such as a laser transducer. The longitudinal distance of the instruments is usually picked up from the vehicle speedometer.

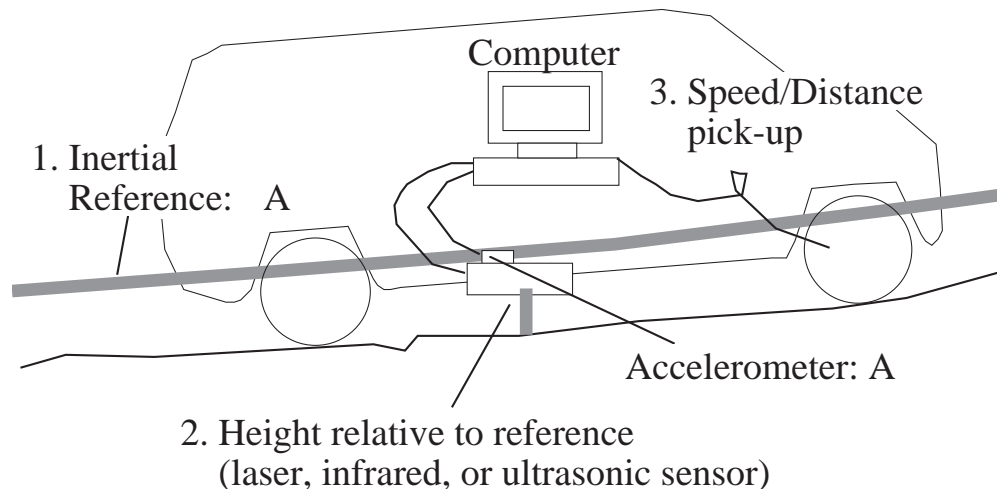

☞ An inertial profiler must be moving to function.

This type of instrument not only works at highway speed, it requires a certain speed even to function. For example, even the best inertial profilers do not work well at speeds less than 15 km/hr.

The connection between the instrument and the ground is harder to see when speeding by at 100 km/hr than when inspecting the imaginary line being profiled on foot and taking readings with a static device. Locating the accelerometer and sensor over the proper imaginary line is difficult and requires an experienced driver.

☞ The profile from an inertial profiler does not look like one measured statically.

The inertial reference from a profiler qualifies as useful, but it is not as easy to visualize as the reference used in the static rod and level or Dipstick. The agreement between the profile obtained with an inertial system and one obtained statically is

good in some respects, but not in others. For example, the next figure shows profiles obtained from the static Dipstick and two inertial profilers.

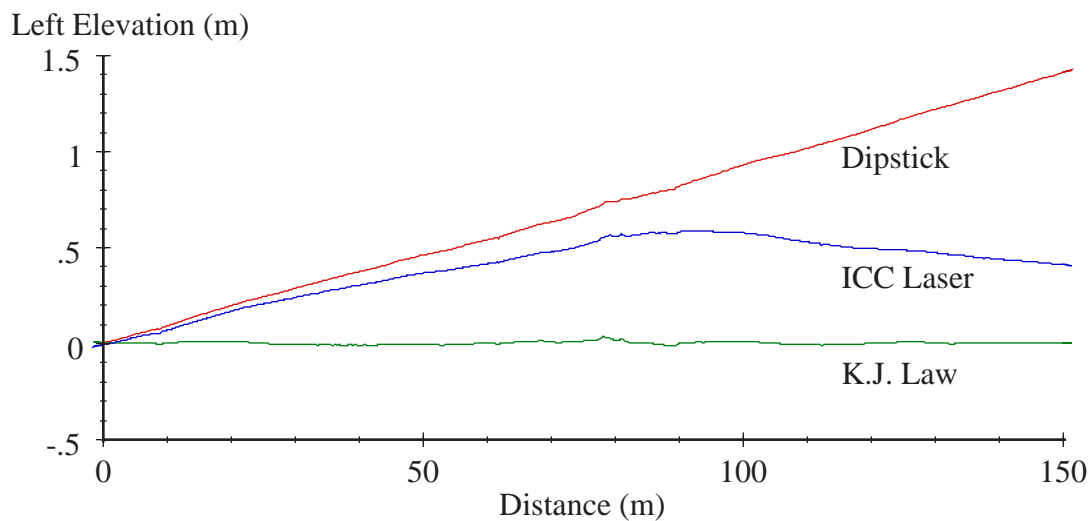

Three profiles measured with different devices.

The profiles from the inertial devices were taken at normal highway speeds, so chances are that the line for the profile was not exactly the same for the three measures. But still, this does not explain the completely different appearances among the profiles. The Dipstick shows a positive grade of about 1 meter vertical per 100 meters longitudinal. The ICC laser profiler shows a grade of up to 0.5 meters vertical per 100 meters longitudinal. The K.J. Law instrument shows a fairly level profile.

The grade and long undulations covering hundreds of meters are not necessarily measured accurately by any of these devices. Plots of elevation versus distance from these three devices do not agree, even though the measures are based on the same true profile. Further, different plots may be obtained for repeated measures of the same true profile, if the measures are made with inertial profilers made by different manufacturers. It is even possible to get different plots from the same instrument, just by choosing different settings before each test.

Accurate profile statistics can be obtained from inertial profilers.

Because the inertial profilers do not produce the same plot of profile as a static method such as the Dipstick, you may at first think they are not useful, or that they are not sensing the true profile. Yet, even if the plot of the profile measured by an inertial profiler does not look like the true profile, it may provide high accuracy for summary numbers that are calculated from the profile. For example, the next figure shows plots of a roughness index (IRI) as computed from measurements made by different instruments. If the two instruments obtained exactly the same results, the points would lie on the line of equality shown in the plots. Although the results are not perfect, the plots show that the different profilers are obtaining essentially the same IRI values. (The IRI will be described later.)

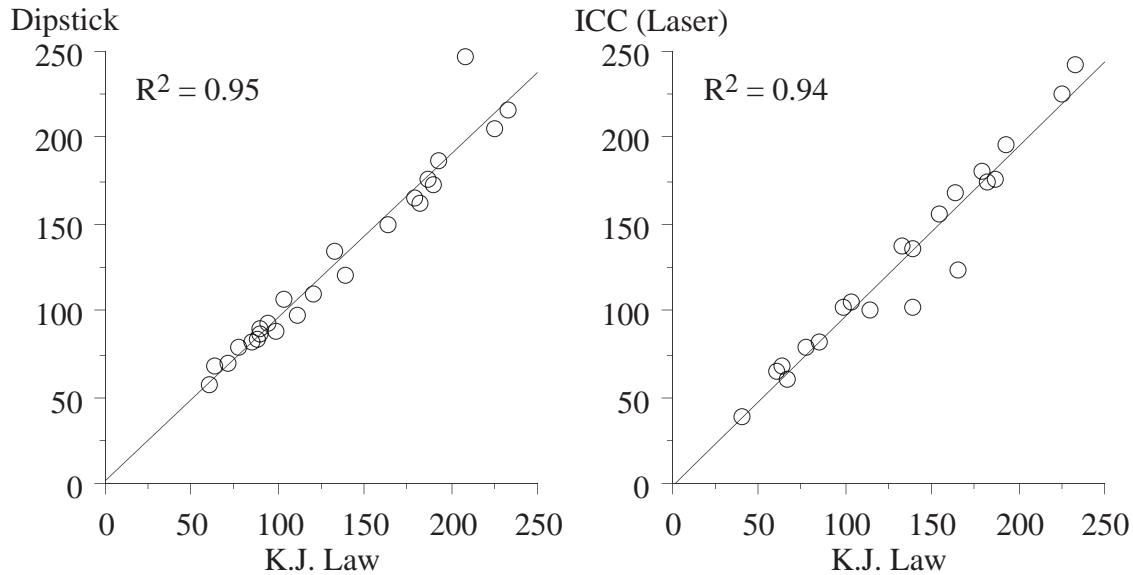

Roughness statistics obtained by different profilers.

We will see many examples of how both static and inertial profilers obtain comparable measures of profile properties.

☞ Measures from inertial profiles can be more reliable than measures obtained statically.

The inertial systems are more automated than the static methods, and, by eliminating many potential sources of human error, can actually be more accurate in many conditions.

☞ The original design has been updated with new sensors and computers.

Early inertial profilers sensed the height of the vehicle relative to the ground using an instrumented follower wheel. The design worked, but the follower wheels were fragile, and required testing at speeds low enough to avoid bouncing. All profilers that are sold today use non-contacting sensors instead of follower wheels.

Early systems performed the profile calculations electronically and required that the vehicle operate at constant forward speed. Modern inertial profilers correct for minor variations in speed and perform the calculations numerically with on-board computers.

☞ Instructions for using an inertial profiler are provided by the manufacturer.

Although most commercially sold inertial profilers operate on similar principals, the specific details of operating them and maintaining correct calibration are not standard. Software for analyzing profiles and reducing them to summary statistics has not been standard in the past, but this is changing. For example, the RoadRuf software is a free Windows-based profile analysis package. RoadRuf is available on the Internet, along with Fortran source code for computing some standard profile-based statistics.

What Can You Do With Profiles?

☞ **There are at least four broad categories of profiler applications.**

1. To monitor the condition of a road network for pavement management systems (PMS),
2. to evaluate the quality of newly constructed or repaired sections,
3. to diagnose the condition of specific sites and determine appropriate remedies, and
4. to study the condition of specific sites for research.

The technical requirements for these categories cover quite a range. A road network may require the measuring of thousands of kilometers per year. In some States, more than 10,000 kilometers per year may be profiled. At the other extreme, a research program might involve frequent measurements of sites that are just several hundred feet long, with the intent of identifying subtle forms of deterioration at their onset.

☞ **Measuring a profile is half the job. The other half is running the profile through a computer program to get a roughness index.**

The most common way to interpret profile information is to reduce road profiles down to summary roughness indices. To obtain information of any type from a measured profile, there are two basic requirements:

1. the profiler must be capable of sensing the relevant information present in the true profile, and
2. computer software must exist to process the measured values to extract the desired information (such as a summary index).

It is possible for the set of numbers obtained for a single profile to be processed several times, using different analyses to extract various kinds of information. However, it can be a challenge to calculate statistics that are useful.

The technology to measure profiles has existed since the 1960's. We are still trying to figure out what to do with the data. Much of the following material in the Little Book will cover the analyses that can be applied to raw profile measurements.

☞ **A profile measure should be relevant.**

The analysis applied to the profile data should be targeted at an application. The fact that a number can be obtained repeatedly and accurately does not make it useful. A relevant measure is one that has been linked by research to properties of the road that are thought by engineers to be important.

For example, two analyses that will be described later are the International Roughness Index (IRI) and Ride Number (RN). Both are linked to roughness. IRI has a demonstrated strong compatibility with equipment used to develop pavement

management systems. Ride Number is linked by statistical correlation to public opinion of rideability.

What is a Valid Profiler?

The word “profile” has appeared in descriptions of road-measuring equipment for several decades. To some users, any device that produces a wiggly line might be called a profiler. However, in this book, we take a more restrictive view that a profiler must produce a wiggly line that has an established relationship to the true profile.

True profile includes a great deal of information. It tells whether the road is going up or down a hill. It gives roughness information. It has texture information.

- ☞ **A true profile contains more information than we can use. Usually, the more information we capture, the more it costs.**

It is neither economical nor useful to measure the true profile with enough detail to extract texture information and also view large-scale landscape features such as hills and valleys. The amount of data storage needed to capture a mile of profile with detail down to the texture level will fill computer storage capabilities rapidly, and make the management of the data base a nightmare. Instead, we measure only a part of the information in a true profile.

- ☞ **A profiler is valid if it provides the same statistical values that would be obtained from the true profile.**

Although valid profilers do not measure all of the information needed for a true profile, they do measure the information that is of interest. Of course, no instrument is perfect, and error exists. Error levels are traded off against the cost of the instruments and the effort needed to use them.

A profiler is considered valid for obtaining a profile property if the statistics obtained from its measures are neither high nor low, on the average, compared with statistics that would be calculated from the true profile.

- ☞ **Statistics from two or more valid profilers are directly comparable, with no conversion required.**

Since a line on the road has only one true profile at some given time, all valid profilers are, by definition, capable of producing the same profile statistics. For example, the same IRI measure can be obtained with rod and level, Dipstick, or many of the currently available inertial profilers.

Profiling is the only technology that has been demonstrated to allow engineers to directly measure the same road roughness statistics using equipment with different proprietary designs and made by competing manufacturers.

Because statistics computed from the measures of a valid profiler are not biased relative to the true profile, we do not have to convert statistical data from a valid profiler to compare them with data obtained from a different valid profiler.

👉 Statistics from valid profilers are stable over time.

The concept of a true profile is one that is simple and depends only on geometry. The definition will be the same in 100 years as it is today. Thus, statistics that are defined on the basis of true profile are timeless.

It is absolutely essential that network data taken this year be directly comparable to last-year's data, and next year's. The need to obtain data about roughness condition that is consistent from year to year may be the greatest factor contributing to the popularity of profilers.

👉 No single device is the best reference for every use.

The validity of a profiler depends on its intended use. Every profiler has a limited range of applications for which it is valid. For example, the Dipstick is valid for determining IRI (a roughness statistic that will be explained later), and also for determining the grade of a road. However, it cannot sense cracks, or "see" profile features that are small relative to the distance between its two supporting feet. The next figure shows a small segment of a profile measured by the Dipstick and by an inertial system developed by FHWA called the ProRut. The ProRut measures profile at a very short sample interval of 50 mm (2 in). They both pick up the basic profile shape, but only the ProRut senses the two deep cracks as 147 m and 156.5 m.

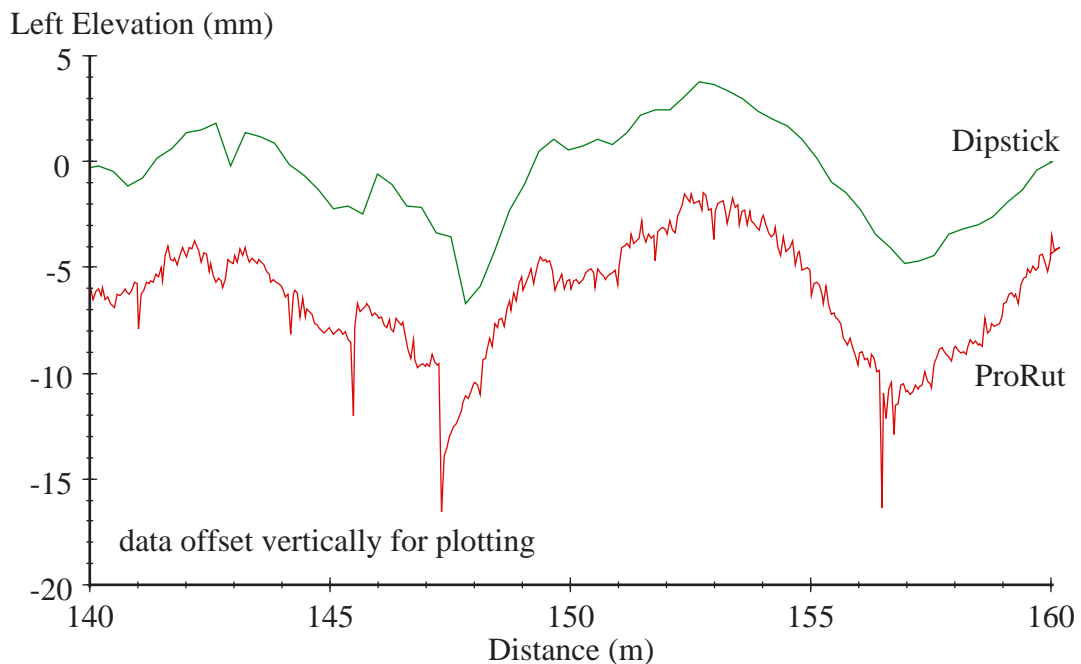

When Is a Profiler Not Valid?

What if the statistics calculated from a profiling device are systematically biased relative to an accepted reference? Say they tend to be 20% high for some tests. You might be tempted to define a “calibration constant” and reduce all values from that instrument by 20%. Don’t Do It!

☞ **A profiler is not valid if its measures are systematically biased.**

If the results are systematically biased, then the device is not valid profiler **for that statistic**. It should not be used to obtain that statistic. Simple.

Although the results might differ by 20% in the first tests, there is no way to estimate the errors on other kinds of roads. Unless the source of the error is known, you do not even know if the error is consistent over time.

A profiler that is not valid for one statistic might still be valid for another. For example, many profilers with ultrasonic sensors are valid for measuring the IRI statistic but not the Ride Number statistic (both IRI and RN will be described later).

☞ **A profiler is not valid if the random error for an individual measurement is too high.**

What exactly does it mean to say the error is “too high?” That depends on the application. For monitoring a large network, large errors are tolerable if they are random. For evaluating specific pavements, the same random errors might be unacceptable.

Near the end of this book, we get back to the topic of validity. We will describe profiling error sources and discuss their significance.

What Is Signal Processing?

Profiling information is used by civil engineers to evaluate the condition of pavements and for managers and planners to manage road networks. However, the technology involved in profiling did not evolve from civil engineering pavement testing methods. The inertial profiler was invented and developed by mechanical and electrical engineers. Many of the methods used to process and analyze profiler measures had already been well-established by electrical and mechanical engineers, and therefore many terms and techniques are used that are not a standard part of a civil engineer’s repertoire.

In order to understand how profiles can be used, profiler users must understand terms such as **signal, signal processing, filter, and frequency response**.

The outputs of the early inertial profilers were voltages that fluctuated in a well-defined relationship to variations in the true profile. In the world of electrical

engineering and instrumentation, a fluctuating voltage that contains information is called a signal.

Modern inertial profilers produce sequences of numbers that contain the same type of information. With modern systems, a sequence of numbers is called a signal.

☞ **A signal is a series of numbers.**

Outputs of the transducers in the profiler are converted to numbers and processed by computer. Several series of numbers exist in an inertial profiler. For starters, there are the values of the transducer variables and the computed profile. Each of these sequences is called a signal.

☞ **Signal processing is the mathematical analysis and transformation of signals.**

Signals are processed mainly for two reasons:

1. to improve the quality of a measurement by eliminating unwanted “noise” from the data, and
2. to extract information of interest from the signal.

The analysis of a road profile falls into the category of signal processing. Also, the calculation of profile from transducer signals is a form of signal processing.

What Is Sample Interval?

The true profile is continuous. It is a slice of the pavement or ground surface. Instruments that produce continuous measures are called **analog**, because the measure is analogous to the variable of interest. For example, a strip chart made with an ink pen is an analog representation. Alternatively, a continuous variable is often represented with a sequence of numbers. This representation is called **digital**.

☞ **Nearly all profiling systems in use today are digital.**

Measures taken with static methods such as the Dipstick or rod and level produce an elevation measure with each static setup. These sequences of numbers are inherently digital— analog versions of a rod and level or Dipstick do not exist.

Inertial profilers have computers connected to the transducers. At some interval of time or distance, the computer “samples” the readings of the individual accelerometers and height sensors. The readings are represented as numbers, and fed into the profile calculation algorithm of the computer to obtain the elevation for the location where the readings were sampled.

Early inertial profilers were analog. They used electronic processors and magnetic tape to store profile as a continuously varying voltage. They have been replaced with

computer-based versions because digital computers offer more analysis options, are much less expensive, and require less maintenance.

☞ **Sample interval is the longitudinal distance between elevation values.**

For the Dipstick, the sample interval is the distance between its two supporting feet. For a rod and level, the interval is the distance between positions where the rod is placed on the ground. For high-speed inertial profilers, the interval is the distance traveled by the vehicle between the times that the computer “samples” digital readings from the transducers.

☞ **Sample interval determines the number of stored elevations per kilometer.**

If sample interval ΔX has units of meters, then there are $\frac{1000}{\Delta X}$ samples per km. A small sample interval means that more storage is needed to record a profile. It also means that analysis of the profile will take longer, because there are more numbers to process. From the viewpoint of efficiency, we do not want to use a sample interval that is too small because we will have to process more numbers than we have to, and allocate more computer storage to save them.

☞ **Sample interval limits the information contained in a profile.**

After a measurement is made, all we know about the road profile are the numbers that make up our measurement. We have no information about what the true profile is doing between samples of the elevation. Ideally, the sample interval is small enough to capture the profile characteristics of interest.

We will see later that many statistics used in the past for representing road roughness have units of slope, such as meters/kilometer or inches/mile. With a profiler, you might suppose that a good measure would be “true slope.” However, there is a theoretical problem: the true slope of a real pavement is infinite! This is because if you look closely, at the texture level, you will find places where the profile is vertical:

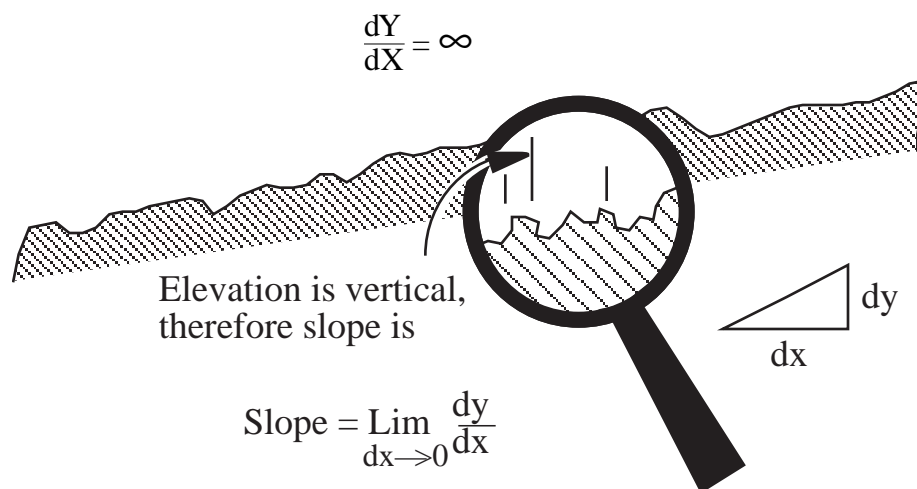

Now consider how the profile is represented with a set of sampled elevations. Instead of a continuous elevation Y as a function of distance X , we have values Y_i where i is the number of the elevation in a data set. The slope between any two points is calculated as

$$\frac{dY}{dX} \approx \frac{Y_{i+1} - Y_i}{\Delta X}$$

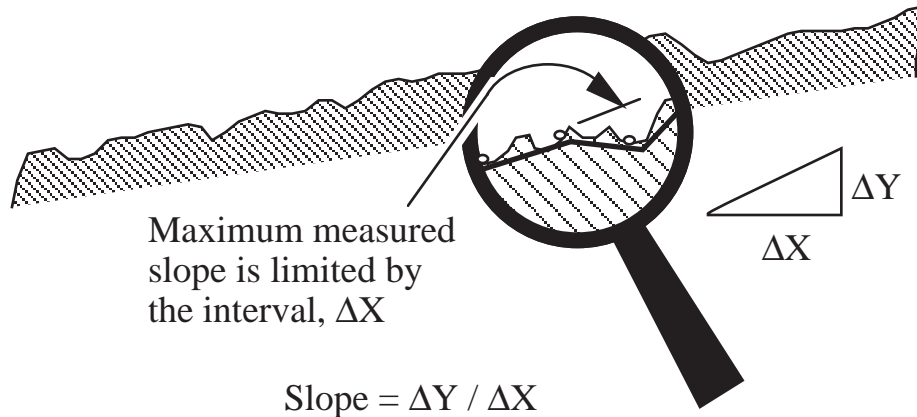

It turns out that the root-mean-square (RMS) value of slope increases the smaller we make ΔX .

If profiler users were to try to report “true RMS slope” as a roughness index, it would be meaningless unless the sample interval were standardized. If one user reports that a road has an RMS slope of 3 m/km (190 in/mi) and another reports that a different road has an RMS slope of 4 m/km (253 in/mi), we cannot say which road is rougher unless we at least know the sample interval. The higher reading could be due more to the use of a short sample interval than the roughness of the true profile.

The next figure demonstrates the effect. It shows the RMS slope for a single profile measurement made at a sample interval (ΔX) of about 50 mm (2 in) and the RMS slope for the same measurement at several simulated sample intervals. The larger sample intervals were obtained by throwing out points from the original measurement. The figure shows that over the range of typical sample intervals for profilers, the RMS slope changes very rapidly. As expected, the RMS slope diminishes with increasing sample interval.

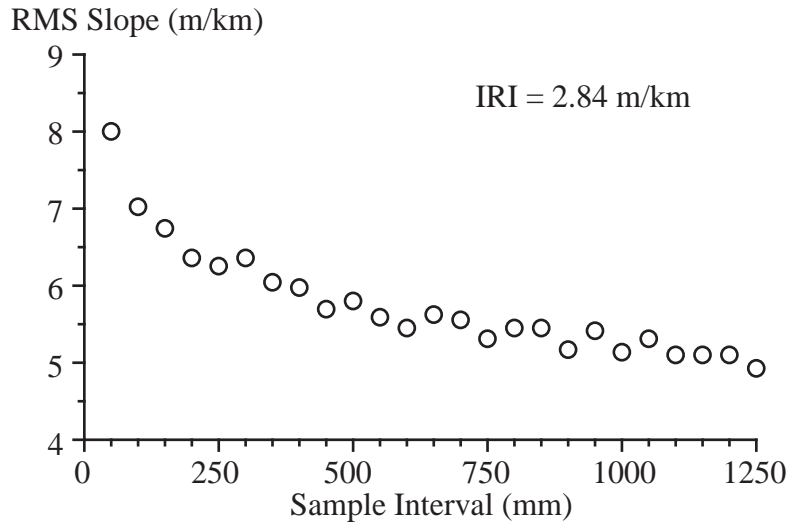

What Is Filtering?

We are all familiar with the use of a filter to clean junk out of liquids such as water and oil. The filter on your faucet traps particles in the water, allowing the water to pass through. In electronics, components or circuits that modify a voltage continuously are called filters. A common application is to “filter out” unwanted voltage fluctuations from a power supply, providing a “clean” power source. Electronic signals are filtered to remove unwanted “noise” and to extract information of interest.

The concept of an electronic filter has been extended to mathematics in general, particularly when a series of numbers is processed by computer.

☞ A digital filter is a calculation procedure that transforms a series of numbers (a signal) into a new series of numbers.

In order to make practical use of a profile measurement, it is almost mandatory to filter the sequence of numbers that makes up the profile. As a profiler user, you do not have to understand the details of the transform, because the calculations are made automatically by a computer. However, it is necessary to understand the significance of filtering, and to think of filtering as a part of profile measurement and interpretation.

For example, consider the three profile measures shown in the next figure. Details of the profile roughness are all but invisible in the plots of the unfiltered profiles.

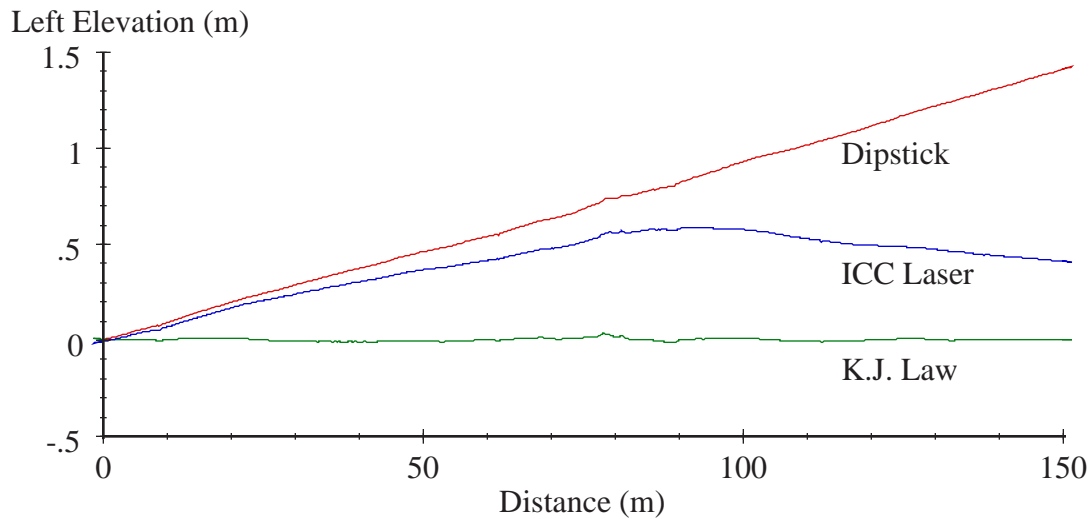

Three “raw” profile measures

- ☞ It is necessary to filter profile data to view different types of profile features.

The next figure shows the same three profiles after they have been filtered to remove the road grade and very long undulations.

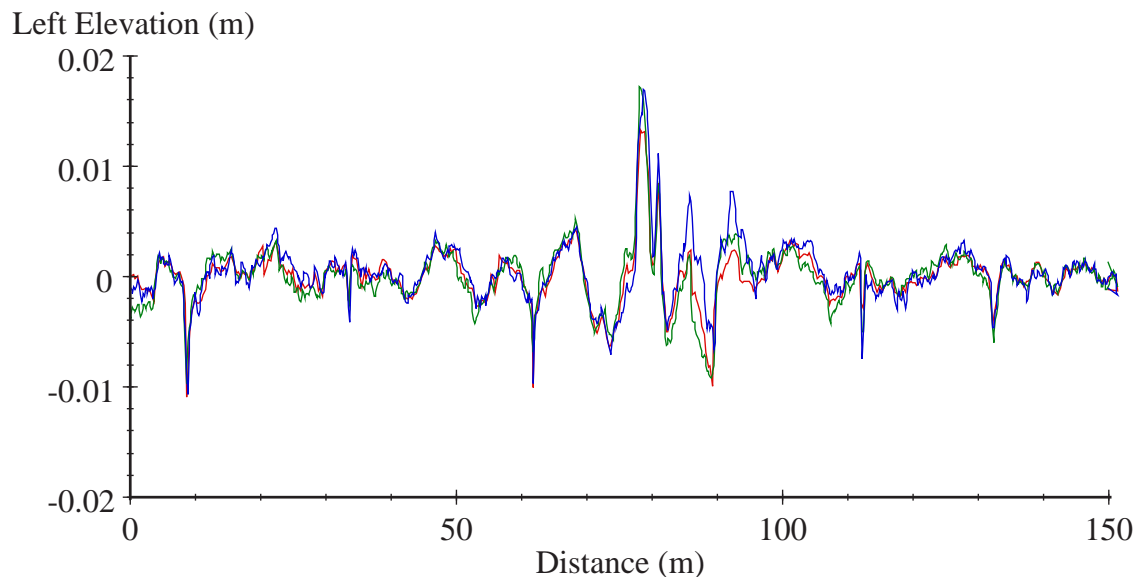

The same profiles after filtering.

Notice the bump at 80 m. It is barely visible in the first figure, because the scaling is set to cover several feet of elevation change. When the grade and long undulations are removed mathematically using filtering, the bump is much easier to see. With a 20-mm magnitude, this is actually a severe disturbance in the road that will get the attention of anyone driving over it.

Filtering is particularly important when viewing data from high-speed inertial profilers. This is because the most visible features of the unfiltered measurement—the underlying grade and overall curvature—are the least accurate parts of the data.

☞ **Filtering profiles is a fundamental part of the measurement process.**

You should be aware that every inertial profiler has at least one filter built into it. Filtering is used to convert the data originating from the accelerometer and the height sensor into the same units. Additional filtering is added to prevent electronic “noise” from causing a large drift in the calculated profile.

Some common analyses involve multiple filters—the output from one filter becomes the input to the next. Conceptually, this is just like putting several electrical filters (circuits) together, or putting several water filters (wire meshes) on your faucet.

☞ **There is not a single filter that is used for all profile applications.**

A filter is just a name for a mathematical transform that modifies a sequence of numbers. There is an unlimited number of filters that can be imagined and programmed. Several standard filters exist, and some of them are routinely applied to road profiles. They will be described in the pages that follow.

What Is a Moving Average?

A moving average is a simple filter commonly used in profile analysis, particularly in creating graphical views of profiles. For example, the plots shown in the previous section were processed with a moving average filter.

☞ **A moving average filter replaces each profile point with the average of several adjacent points.**

For a profile p that has been sampled at interval ΔX , a moving average smoothing filter is defined by the summation:

$$p_{fL}(i) = \frac{1}{N} \sum_{j=i-\frac{B}{2\Delta X}}^{i+\frac{B}{2\Delta X}} p(j)$$

where p_{fL} is the smoothed profile (also called a “low-pass filtered profile,” for reasons that will be explained later), B is the base length of the moving average, and N is the number of samples included in the summation.

The effect of a moving average filter is demonstrated in the figure below. The effect is to smooth the profile by averaging out the point-by-point fluctuations.

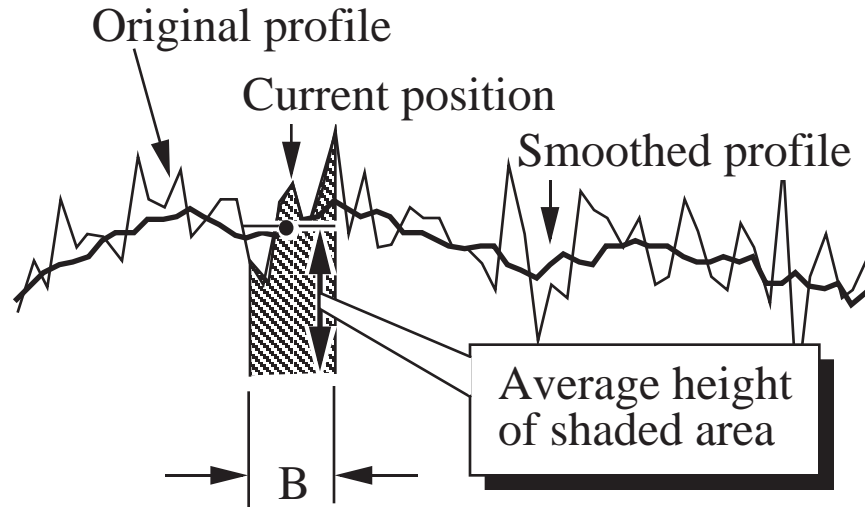

The moving average filter.

☞ **A moving average can also be used to remove the smoothed profile.**

In most cases, we are not interested in looking at a highly smoothed profile. That just tells whether the road is going up, down, or staying level. With an inertial profiler, the long-duration slope information is not even accurate. Instead, we are interested in the deviations from the smoothed profile. After all, it's the deviations that degrade vehicle ride and annoy the traveling public.

A simple modification of the moving average filter is to subtract the smoothed profile from the original:

$$p_{fH}(i) = p(i) - \frac{1}{N} \sum_{j=i-\frac{B}{2\Delta X}}^{i+\frac{B}{2\Delta X}} p(j)$$

In this case, the filtered profile has the subscript H for "high-pass filter," for reasons that will be explained later.

Both the smoothing (low-pass) and the opposite (high-pass, anti-smoothing) forms of the filter are useful. Both versions can be used on the same profile, although it only makes sense to do this if the base length B is longer for the anti-smoothing version than the base length for the smoothing version.

☞ **There is no single best base length for profile interpretation; the best setting depends on the use to be made of the data.**

For example, the following three plots show the profile of a faulted PCC pavement section filtered three different ways, each showing a different kind of information.

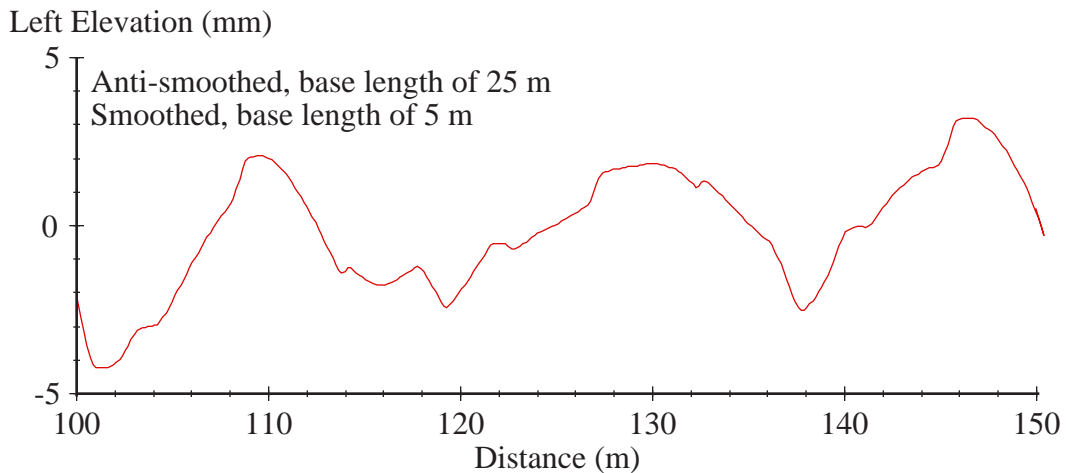
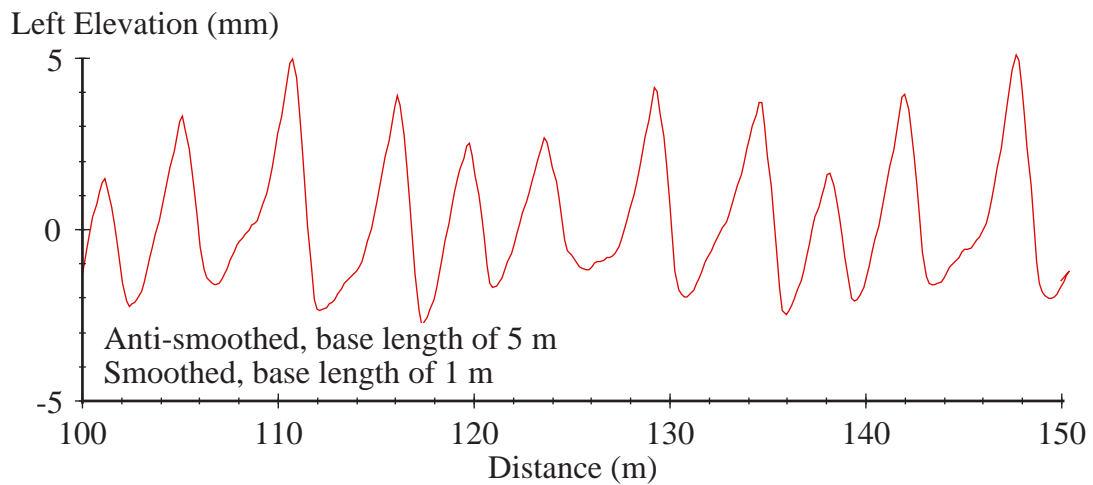
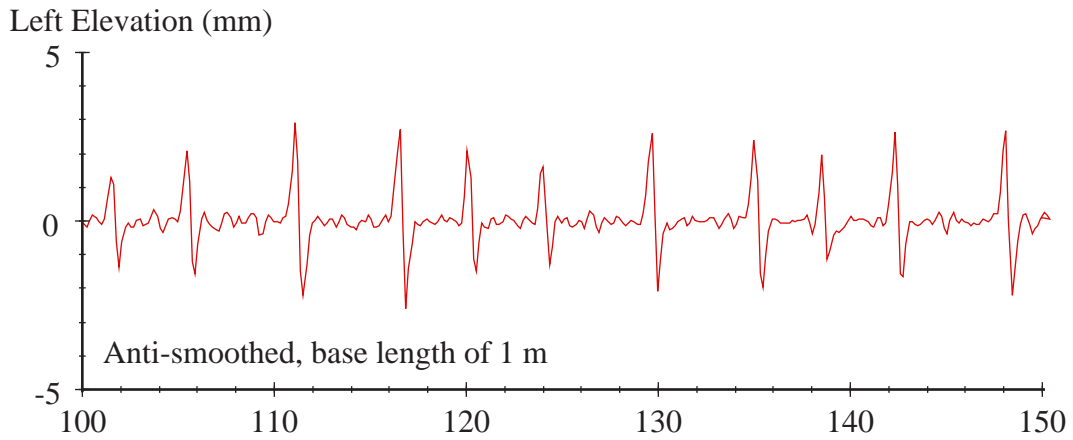

The first plot was filtered with the anti-smoothing version of a 1-m moving average. (The smoothed profile is subtracted from the original.) This plot shows only the very short-duration bumps in the profile. The faults, spaced about 4.5 meters apart, are very obvious.

The second plot shows the profile after processing with a 1-m smoothing filter and 5-m anti-smoothing filter. All of the deviations shown in the first plot are

completely eliminated in the second. Although the abruptness of the faults and the surface harshness have been eliminated, the tilt of the slabs is clearly visible.

The third plot shows the profile after processing with a 5-m smoothing filter and 25-m anti-smoothing filter. In this case, all of the deviations shown in the first two plots are eliminated through the 5-m smoothing. The slope and very long undulations are removed with the 25-m anti-smoothing filter. This remaining deviations illustrate longer-duration trends in the road, without the faulting or slab shapes.

 **A moving average filter is computationally efficient.**

The moving average filter is an intuitive way to smooth a profile that is easy to understand and program. It is also efficient computationally, because after the first average point is calculated, subsequent values can be obtained with the relation:

$$p_{fL}(i) = p_{fL}(i-1) + \frac{1}{N} \left[p\left(i + \frac{B}{2\Delta X}\right) - p\left(i - \frac{B}{2\Delta X} - 1\right) \right]$$

Even if the average covers hundreds of points, it is only necessary to account for the effect of two profile values: one entering the averaging interval, and one leaving the interval.

 **Free computer software is available for making profile plots with a moving average.**

The smoothing and anti-smoothing versions of the moving average are integrated into a free Windows package called RoadRuf that is available from the Internet. The RoadRuf software can be found at:

<http://www.umtri.umich.edu/erd/roughness/rr.html>

What Are Sinusoids?

Sine and cosine waves are both called sinusoids.

In order to understand profile analyses, it is essential to be familiar with sinusoids.

Throughout the rest of this book, we will be considering wavelengths and frequencies when we looking at topics such as how filters work, how vehicle ride is related to roughness, how various roughness measures are defined, and how measurement errors are caused.

 **A sinusoid is defined by a wavelength, amplitude, and phase.**

The equation of the sinusoid (Y) as a function of X is:

$$Y = A \sin\left(\frac{2\pi}{\lambda} (X - X_0) \right)$$

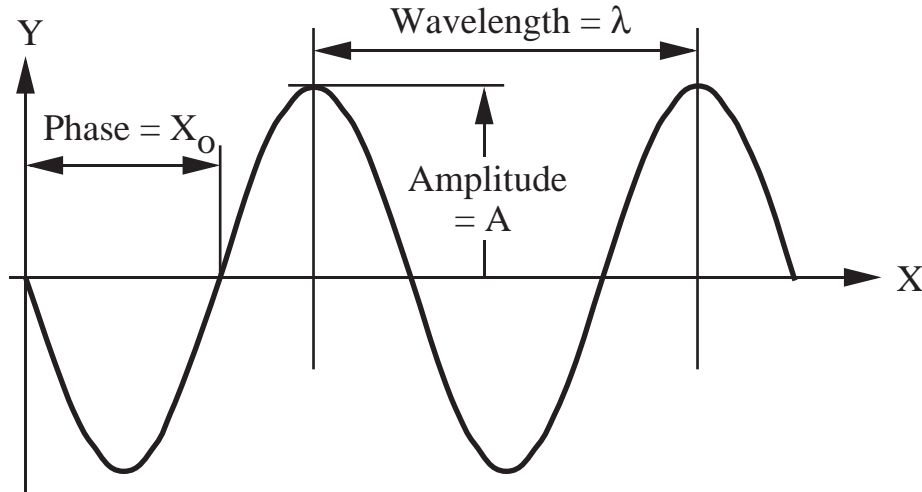

☞ **Wave number is the number of cycles per unit length.**

An alternative to defining the length of a cycle is to define how many cycles occur in a unit of length. In many signal processing applications, sinusoids are defined as functions of time, rather than distance, and the convention is to define the sinusoid with the frequency of cycles per second, called Hertz (Hz). When sinusoids are defined as functions of length, the frequency of cycles per length is called wave number, and is written as ν ($\nu = 1/\lambda$). Wave number usually has units of cycle/m or cycle/ft.

☞ **It takes at least two samples per cycle to “see” a sinusoid.**

In order to “see” a sinusoid in a digital signal (e.g., a sampled road profile), it is necessary to set the sample interval to be no larger than $1/2$ the wavelength of the sinusoid, as shown below. This is called the “Nyquist sampling theorem.” For example, if we think information in the true profile is of interest for wavelengths of two feet and longer, then the sample interval must be one foot or shorter.

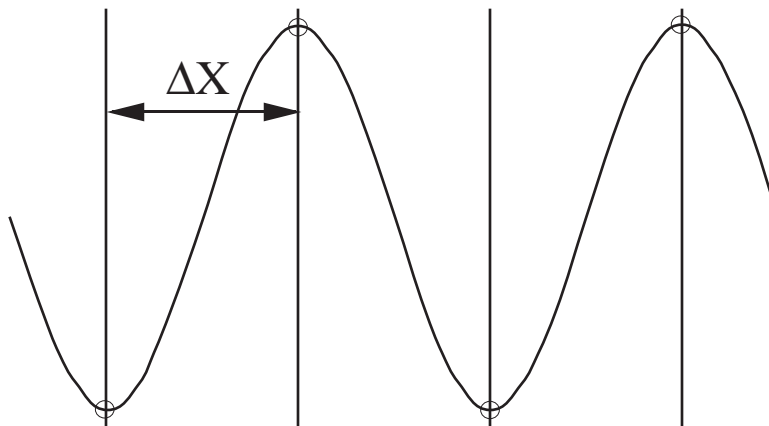

What Is Frequency Response?

It is almost essential for profiler users to be familiar with the concept of a frequency response, because profile analyses are nearly always described with a frequency response plot.

Filters, instruments, vehicles, and other systems can be thought of as conceptual “black boxes” with an input and an output. Frequency response is a highly useful way to describe the input/output behavior of any of these systems.

☞ **A linear system is one in which the output is proportional to the input.**

If you have the response of a linear device to a bump in the road, then if the bump is scaled up by some factor, the output of the device has exactly the same form, but it is also scaled up by the same amount. For a profile analysis, the test is applied to sets of numbers that are inputs and outputs of the analysis. If the input numbers are changed by a scale factor, the output numbers are changed by the same scale factor if the analysis is linear.

All of the filters described in this little book are linear. (Some of the methods used to accumulate the outputs after they are filtered involve nonlinear mathematical functions such as squaring or taking absolute values. However, the filtering process, which is done first, is linear.)

☞ **A sinusoidal input to a linear system causes a sinusoidal output with the same wavelength.**

In general, the amplitude and phase are different for the input and output. However, the wavelength is the same for a linear system. For example, consider the moving-average filter. The next figure shows a sinusoid with a 6-m/cycle wavelength as affected by a three moving-average smoothing filters with several base lengths.

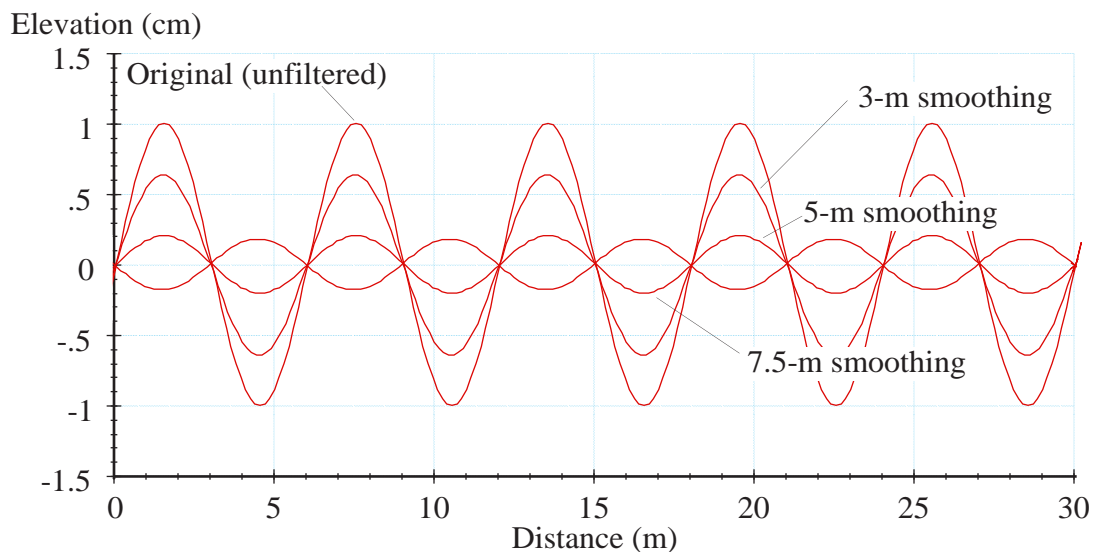

Notice that the three filtered outputs are also sinusoidal.

☞ **A frequency response plot shows the ratio of output to input for a sinusoid.**

Knowing that the output of a linear system is a sinusoid with the same wavelength, the output can be completely defined by the amplitude and phase. An amplitude frequency response plot shows the ratio of the output amplitude to the input amplitude. The amplitude ratio is called the **gain**. A phase frequency response plot shows the phase of the output sinusoid relative to the input. However, in this book, we will limit our attention to plots of gain.

The next figure shows a plot of the gain of a moving average filter as a function of wave number. Compare the results for the previous figure with the gains shown in the figure below (see the line labeled “Low Pass”). For the 3-m base length, the ratio of base length/wavelength is 0.5. The frequency response plot shows a gain of 0.64, which matches the amplitude shown earlier. For the 7.5-m base length, the ratio is 1.25 and the gain is -0.18 , which also matches.

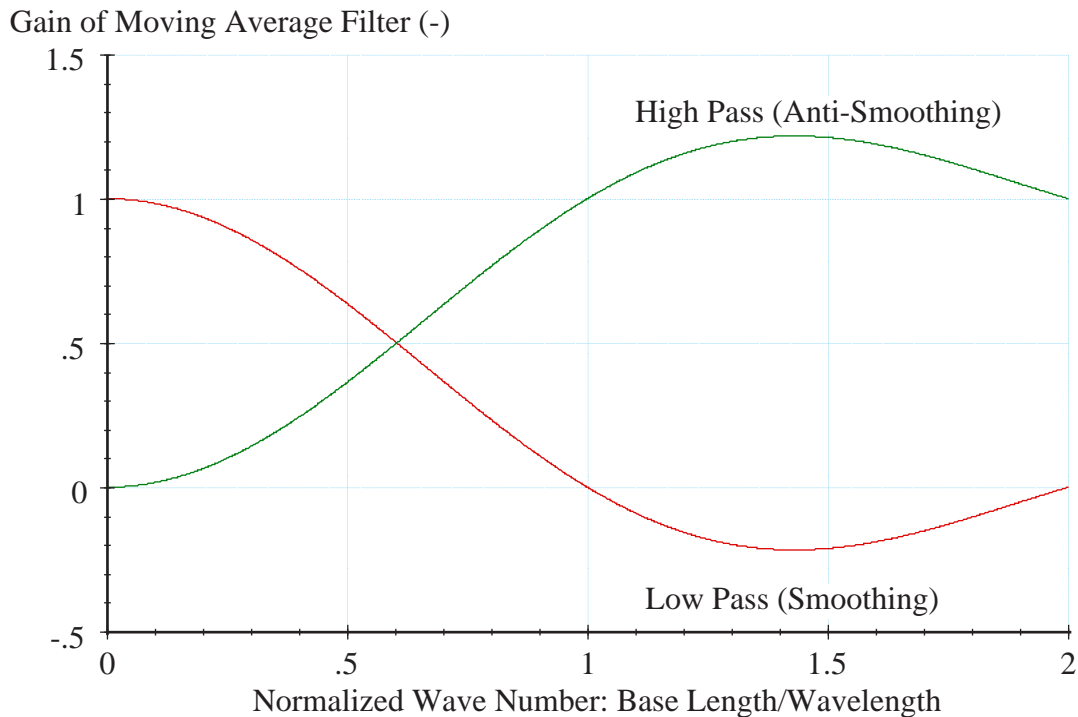

☞ **A moving-average smoothing filter is called a low-pass filter.**

Like any other filter, some things pass through unchanged, some things are reduced, and some might be removed completely. We saw before that the amplitude of the 6-m sinusoid is reduced slightly by a 3-m moving average. For a 5-m moving average, it is reduced substantially. For a 6-m moving average, it would be removed completely. For a 7.5-m moving average, the sinusoid is not removed. The amplitude is reduced in magnitude, and has an opposite sign. (It is sometimes said to be out of phase.)

Overall, the filter attenuates sinusoids with wavelengths approaching the base length, and leaves sinusoids with longer wavelengths nearly intact. In terms of wave numbers, it attenuates high wave numbers and passes low wave numbers. For this reason, it is called a **low-pass filter**.

☞ **The anti-smoothing version of the moving average is a high-pass filter.**

Recall that the anti-smoothing version of a moving average involves subtracting a smoothed profile from the original. That means the frequency response gain for the anti-smoothing version can be derived by taking one (1.0) minus the gain of the smoothing version. The previous figure shows both response functions. At any given wave number ratio, the two gains sum to unity.

Filters can also amplify signals. Note that the high-pass (anti-smoothing) version of the moving average amplifies sinusoids when the ratio of base length/wavelength is between 1 and 2. The next figure shows how the high-pass version of the moving average affects a 6-m sinusoid. If you read off the amplitudes from the three filtered plots, you should find that they match the gains shown in the previous plot of frequency response.

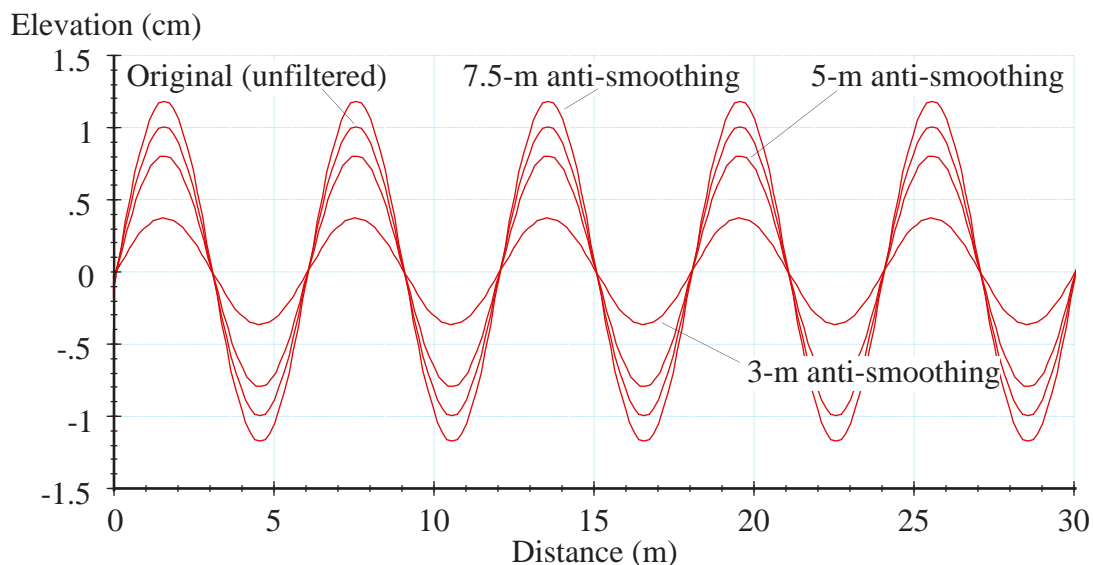

☞ **High-pass and low-pass frequency response plots are easily re-scaled.**

Suppose you want to see the effect of a 30-m moving average high-pass filter. The previous plot shows the effect of a 3-m base length on a 6-m sinusoid. If the X axis were re-scaled by a factor of 10, to go from 0 to 300 m, then the base length would be 30 m and the response shown would be correct for a 60-m sinusoid.

Gains of filters often depend on the ratio between wavelength and a filter parameter. Therefore, they are often plotted using normalized frequency or wave number, as was done in the moving average frequency response plot.

☞ **A Bode plot is a frequency response plot made on log-log axes.**

If the log of the filter gain is plotted against the log of wave number or frequency, the graph is called a Bode plot. Electrical engineers use Bode plots to characterize systems as an aid for designing control systems

What Is a Power Spectral Density?

A typical road profile has no direct resemblance to a pure sinusoid. As we will see shortly, a typical road profile encompasses a spectrum of sinusoidal wavelengths. The power spectral density (PSD) function is a statistical representation of the importance of various wave numbers.

☞ **Profiles can be decomposed into a series of sinusoids.**

An arbitrary shaped “wiggly line” can be constructed mathematically from a series of sinusoids with different wavelengths, amplitudes, and phases. For example, consider a step change. The next figure shows how several sets of sinusoids are added together to approximate the step.

If a single sinusoid is used, whose wavelength is the same as the distance covered in the plot, the amplitude and phase are set to provide only the crude approximation indicated for $N=1$. It turns out that for the step change shown, the amplitudes for all sinusoids whose wavelengths are an even divisor of the length ($1/2$, $1/4$, $1/6$, etc.), the amplitude should be zero—adding a sinusoid does not cause the approximation to match the step any better. However, for wavelengths that are odd divisors (1 , $1/3$, $1/5$, etc.), each additional sinusoid improves the approximation. The plot shows that a close approximation is obtained for a large number of sinusoids (e.g., $N=99$).

The general method of “building” a step change with sinusoids works also for an arbitrary profile. If a profile is defined with $2N$ equally spaced elevation points, then it can be duplicated mathematically with N sinusoids. Because there are so many sinusoids being added, their individual amplitudes are not large. A mathematical transform exists which computes the amplitudes of the sinusoids that could be added together to construct the profile. It is called a Fourier transform. The Fourier transform can be scaled such that it shows how the variance of the profile is “spread out” over a set of sinusoids. When scaled in this manner, the transform is called a power spectral density (PSD) function.

☞ **A PSD function shows how variance is distributed over wave number.**

The PSD function was originally developed for characterizing voltages. The same mathematical calculations can be applied to road profiles. Two differences between a road profile PSD and one measured for a voltage are (1) the variance has units of elevation squared, rather than volts squared, and (2) the distribution is over wave number (cycle/meter or cycle/ft) rather than frequency (cycle/sec).

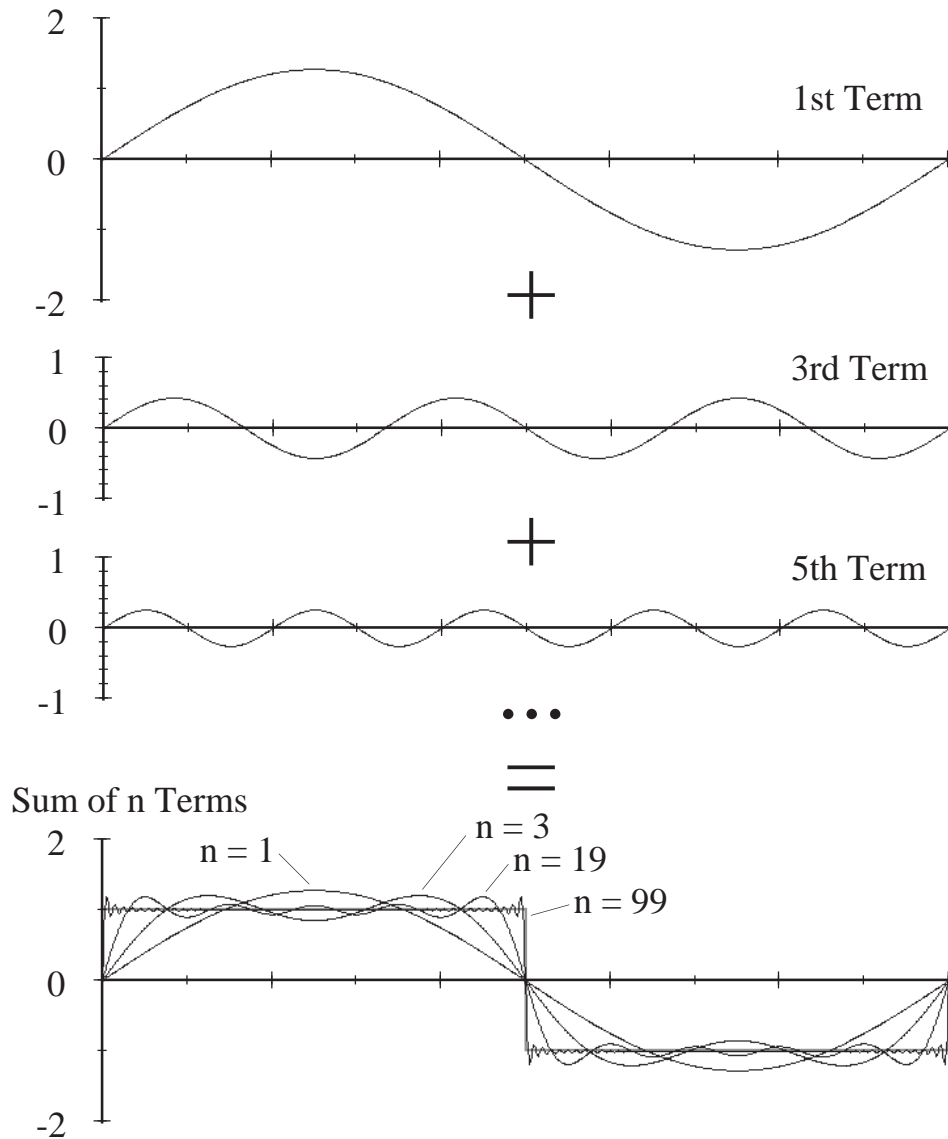

👉 Power spectral density has nothing to do with power!

The “power” in the name comes from its early application in electronics, where it was applied to voltages. The variance of a voltage is proportional to power in a resistor, so the PSD illustrated the distribution of electrical power over frequency. A road PSD has absolutely no relation to power.

Consider two road profiles with similar summary roughness properties, but obviously different profile shapes. (The IRI statistic used to define overall roughness levels will be described later.) The profiles are shown in the next figure. Site 4 has large, long undulations typical of bituminous roads. In contrast, Site 7 show less overall variation, but more “harsh” variation, as is typical in PCC roads.

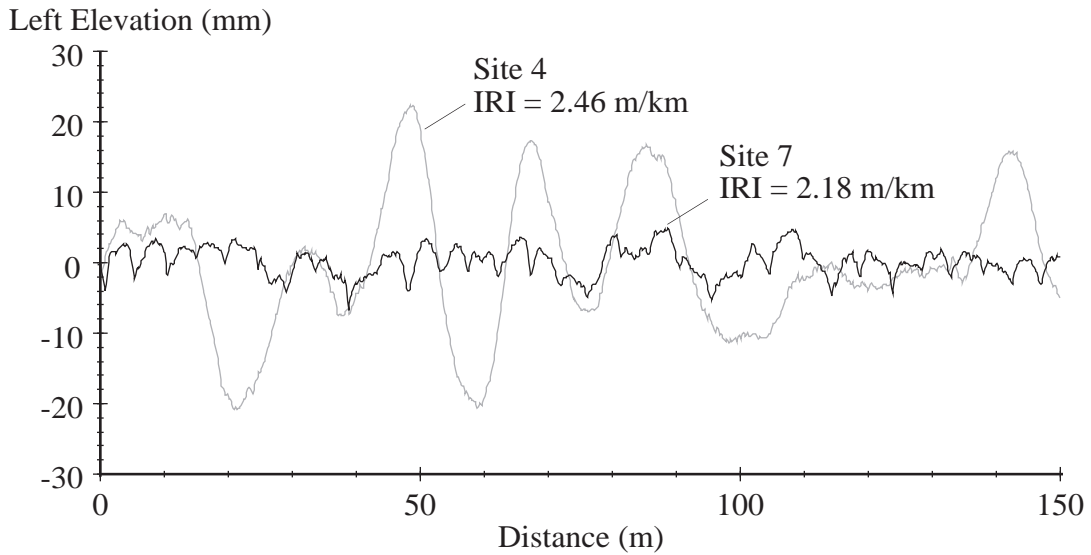

The PSD functions for the two profiles are shown next. At first glance, the two PSD functions have more in common than not. The PSD amplitudes cover many orders of magnitude. For low wave numbers, the amplitudes are much higher than for high wave numbers. Even with this commonality, however, the two PSD plots reveal the characteristic differences in the profiles. The PSD for Site 4 has relatively higher amplitudes for low wave numbers in the vicinity of 0.03 cycle/ft (33-m cycles), corresponding to the undulations visible in the preceding plot. On the other hand, Site 4 has lower amplitudes at higher wave numbers near 0.3 (3.3-m cycles).

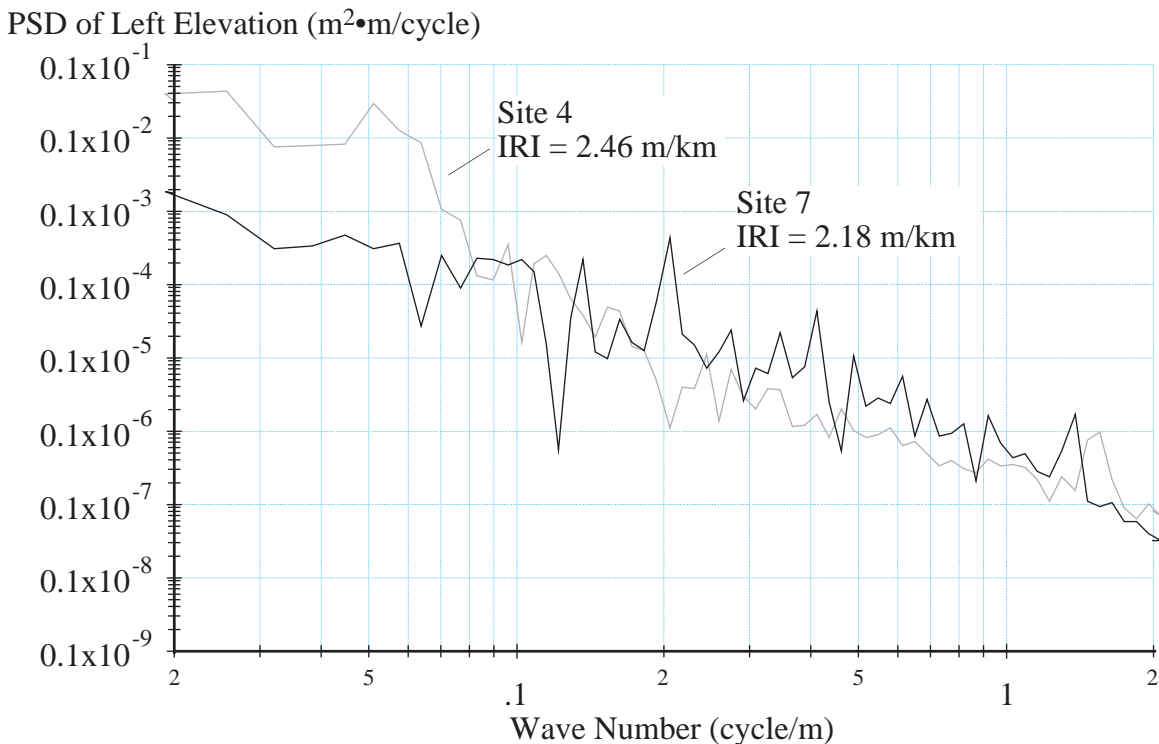

👉 Amplitude in profile elevation grows with wavelengths.

The preceding plot supports what we have already seen from profile plots. We have seen that when profiles are filtered using software to attenuate long wavelengths, the resulting profiles show very small variations. An unfiltered profile might show variations of several meters. When filtered to remove grade and long undulations, the range of variations might cover only a few centimeters. Thus, we have seen that long wavelengths are associated with high amplitudes of elevation variation.

The exact relationship between amplitude and wave number (or its inverse, wavelength), varies between different profiles. However, all roads show a similar basic trend. On average the amplitude diminishes rapidly with wave number.

👉 Amplitude in profile slope is more uniform than in elevation.

PSD functions can be computed for derivatives of profile elevation, such as slope and curvature (spatial acceleration). PSD functions of profile slope best show differences in roughness properties, because the basic spectrum of roughness over wave number is more uniform. The next figure shows the slope PSD functions for the same two examples.

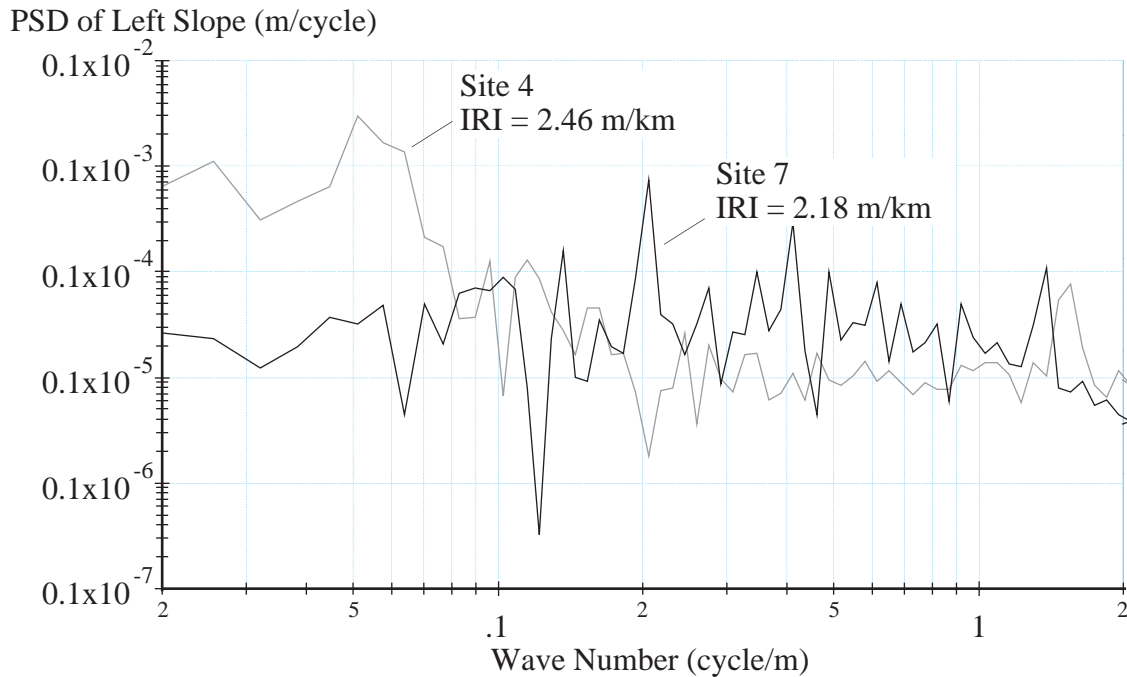

Notice that with this type of plot, the differences between the two roads stand out clearly: Site 4 is rougher for wave numbers less than 0.1 (10-m cycles), and smoother for wavelengths between 0.2 (5-m cycles) and 1 (1-m cycles).

What is Vehicle Ride?

The purpose of a road is to provide a surface for vehicles to run over at high speeds. A primary objective for profilers is to try to gather information about the road that is sufficient to estimate the satisfaction of the motoring public. The judgment of the public depends in a large part on the ride experienced in their automobiles when using the road.

👉 Ride is measured as accelerations in the vehicle body.

Automotive ride engineers measure accelerations on the seat to evaluate the suspension performance and the match between front and rear suspension stiffness and damping.

👉 Seat vibrations are used to evaluate suspension tuning.

Sensitivity to vibration of the human body in a sitting position has been quantified by numerous studies. The figures below show sensitivity to vertical acceleration and horizontal (longitudinal or lateral) obtained from a sampling of research.

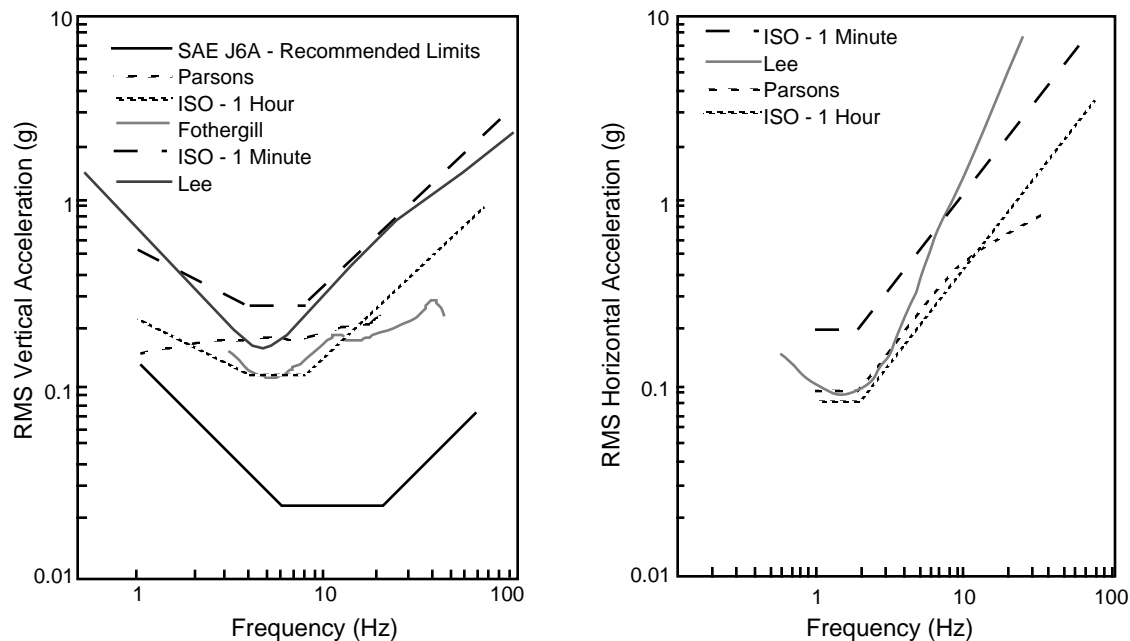

It is generally recognized that the human body has minimum tolerance to vertical vibration at about 5 Hz due to resonance of the abdominal cavity. Thus cars are designed to minimize transmission of road inputs at this frequency by placing the body bounce and pitch frequencies at 1-2 Hz and the wheel hop resonance at 10-15 Hz. (The different levels of tolerance found in the different studies reflects variations in the experimental methods used.)

Minimum tolerance for horizontal acceleration occurs at 1 Hz. Horizontal (lateral) acceleration may be caused by vehicle roll. Most primary roads do not produce much roll excitation, although it can be significant on some deteriorated secondary roads. The effects on the rider are more pronounced on high vehicles such as vans, utility vehicles and trucks.

Horizontal (longitudinal) acceleration can result from pitch on vehicles that place the rider high above the ground (vans, utility vehicles and trucks). Ride engineers normally tune the front and rear suspensions to minimize pitch, however, it is not always possible on trucks. Hence, truck drivers experience more pitch induced longitudinal vibrations from road roughness than occupants of passenger cars.

Under conditions with lower vertical vibration (e.g., luxury cars, smooth roads) the 5 Hz sensitivity is less pronounced. At low levels of acceleration the human sensitivity becomes more broad in frequency as shown in the figure below.

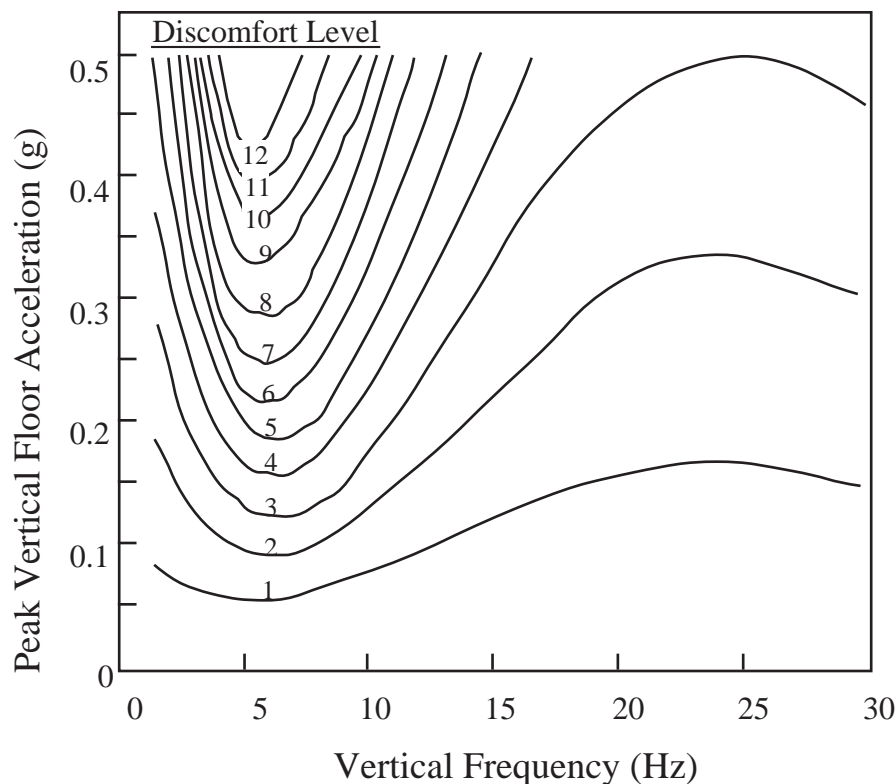

☞ There are important vibrations other than at the seat.

Vehicle ride is not judged only by seat vibrations. Automotive engineers recognize that vibrations felt by the hands and feet also influence ride perception. They expend considerable engineering effort trying to isolate the steering wheel from vibrations excited by the road or from shake of the vehicle body. They also work hard to keep road excitation from vibrating the floor.

How Is Vertical Acceleration Related to Profile?

Given that vertical acceleration is of great interest for summarizing vehicle ride, it is important to understand the relationship between profile elevation and acceleration. Consider three sinusoids shown below. (The IRI and RN statistics provided in the figure will be defined later.)

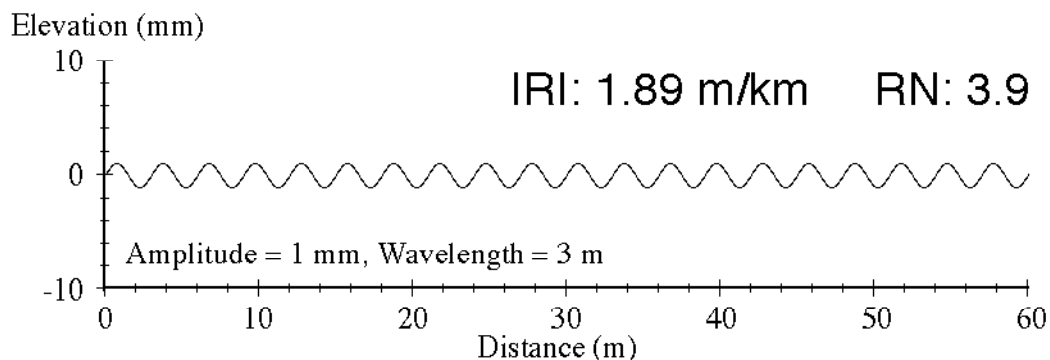
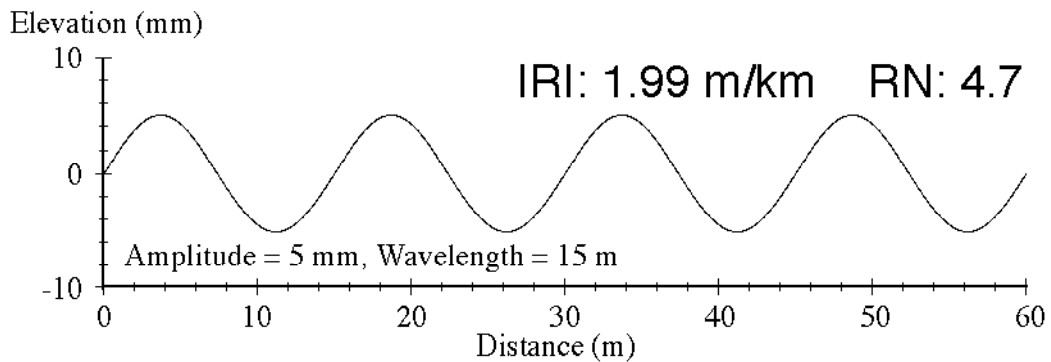
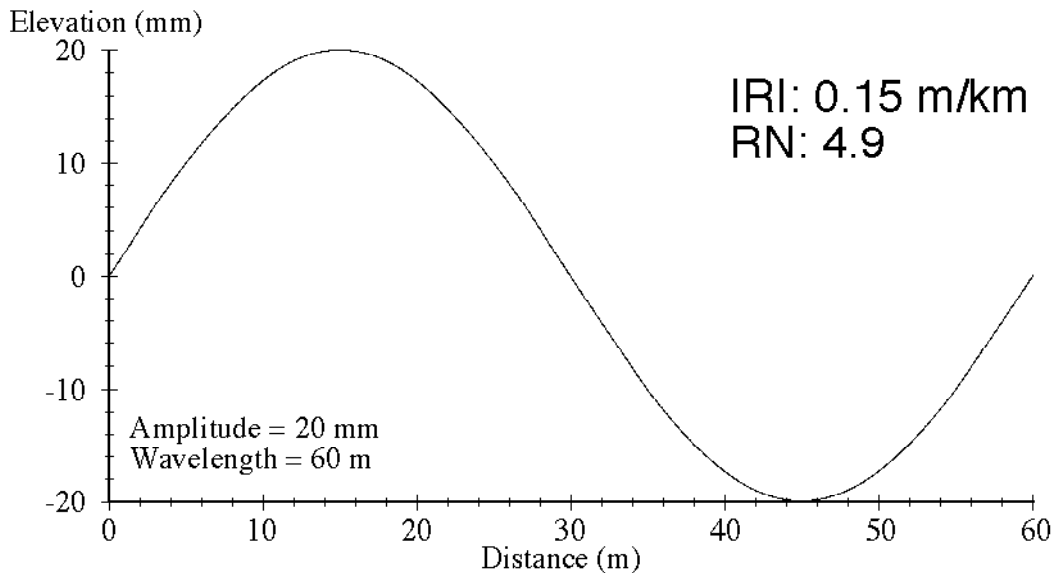

☞ The derivative of a sinusoid is a sinusoid with the same wavelength.

The amplitude of the derivative of a sinusoid is

$$\text{Slope amplitude} = \frac{2\pi A}{\lambda}$$

Amplitude A and wavelength λ should have the same units (e.g., ft, m). Multiply m/m by 1000 to get m/km, or multiply by 12•5280 to get in/mi.

Thus, the derivatives of the three example sinusoids are also sinusoids with the same wavelengths (60, 15, and 3 m). The formula above gives identical derivative amplitudes for the three sinusoids, as shown in the next figure. (The amplitude in dimensionless slope is 0.002094, which is the same as 2.094 m/km and 132.7 in/mi.)

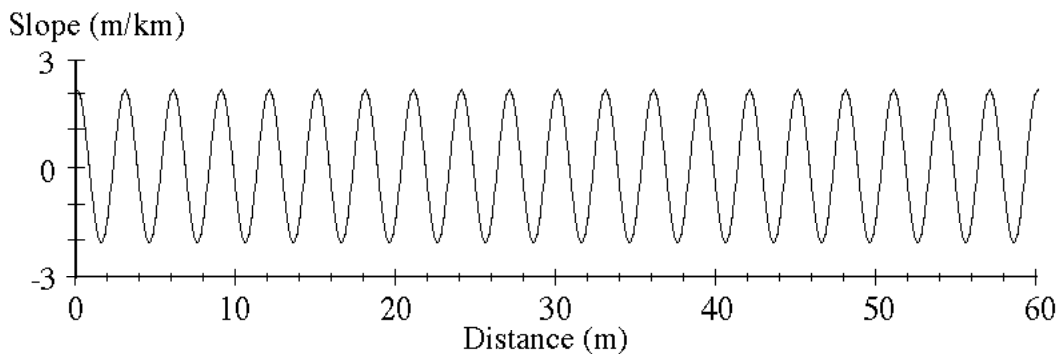
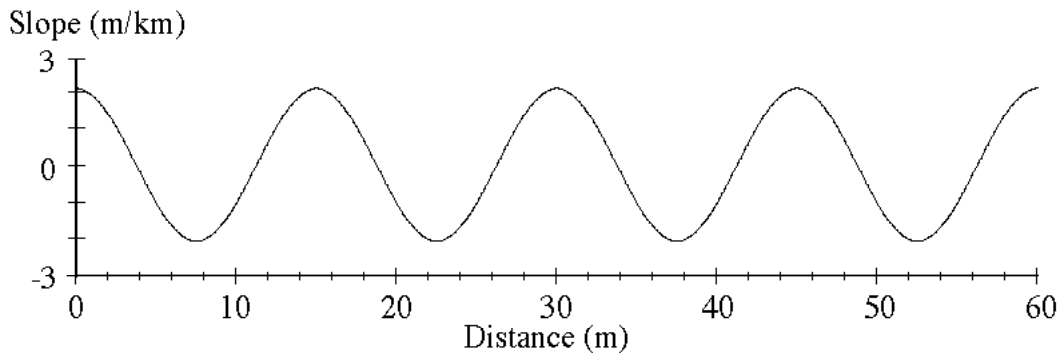
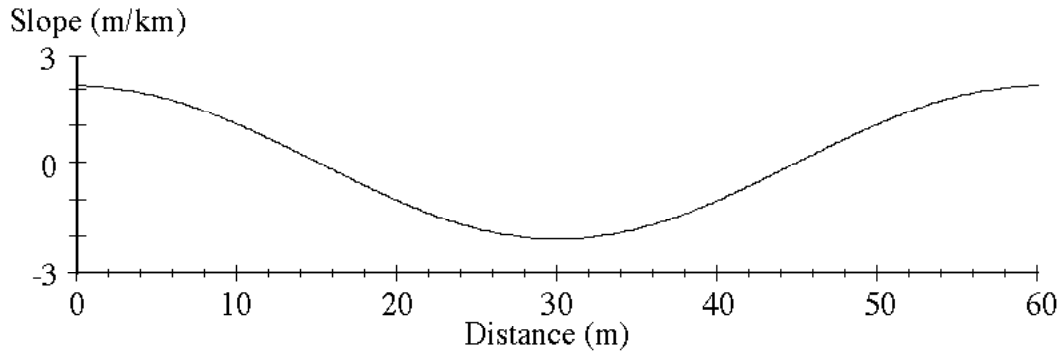

The process of taking a derivative can be repeated a second time to get a spatial acceleration sinusoid.

☞ Travel speed affects how vehicles see sinusoids in the road.

A vehicle moving over the road “sees” a sinusoid at a frequency

$$f = \frac{V}{\lambda} = V v$$

where frequency f has units of cycle/sec, speed V has units of distance/time (e.g., m/sec), wavelength λ has units of length (e.g., m/cycle), and wave number v has units of 1/length (e.g., cycle/m).

The table below summarizes some characteristics of the three example sinusoids for a speed of 108 km/hr (67 mi/hr). Although the first has the largest elevation amplitude, the third produces the largest vertical acceleration.

Wavelength	Amplitude	Slope Amplitude	Frequency (108 km/hr)	Acceleration (108 km/hr)
60 m	20 mm	2.09 m/km	0.5 Hz	0.02 g
15 m	5 mm	2.09 m/km	2.0 Hz	0.08 g
3 m	1 mm	2.09 m/km	10.0 Hz	0.40 g

☞ Road PSD functions can be shown as accelerations.

The insight obtained by looking at the three example sinusoids can be extended to the broad spectrum of frequencies (wave numbers) in typical roads. The figure below shows the road as an elevation PSD input (see the plot on the left) when the travel speed is 80 km/hr (50 mi/hr). Differentiating once produces the spectrum of velocity excitation, and differentiating again yields the acceleration PSD. Note that acceleration input is greatest at high frequencies, corresponding to short wavelengths in the road.

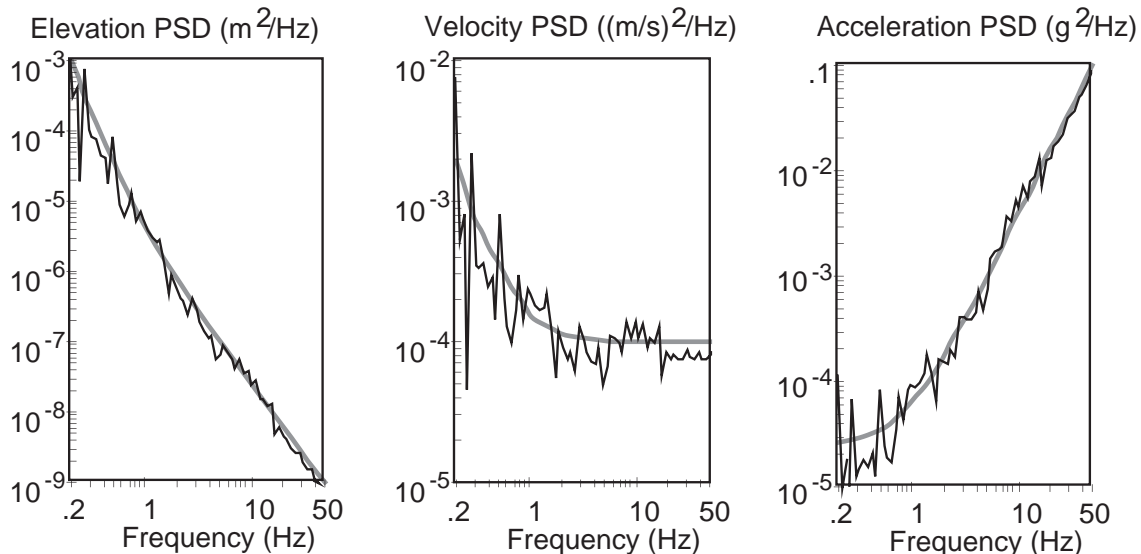

The assumed travel speed acts to scale the PSD functions. However, the basic shape of the road PSD function is the same as when calculated as a function of wave number. The elevation PSD with units of $\text{length}^2/\text{Hz}$ has the same basic shape as the elevation PSDs shown earlier as functions of wave number. Only the units are changed, to involve time rather than distance. The velocity PSD has the same shape as the slope PSD. Although it has not been shown, the acceleration PSD corresponds to a spatial acceleration PSD.

How Does Ride Relate to the Road?

Although road roughness is a dominant source of vibration on a motor vehicle, the public is able to separate the role of the car from that of the road. A Michigan DOT experiment some years ago showed that when people are asked to rate the **ride** of a vehicle on the road, they are influenced by the type of car (luxury or compact) that they are riding in. However, if asked to rate the **road** they tend to look beyond the vehicle and rate the roughness of the road comparably regardless of the type of vehicle they are riding in.

☞ **Car suspensions isolate the rider from the severe acceleration inputs of the road.**

At the most basic level, motor vehicles are dynamically similar to the quarter-car model. The suspension supporting the body (sprung mass) and the compliance in the tire help to isolate the body from high frequency road excitation. The figure below shows the dynamic characteristics

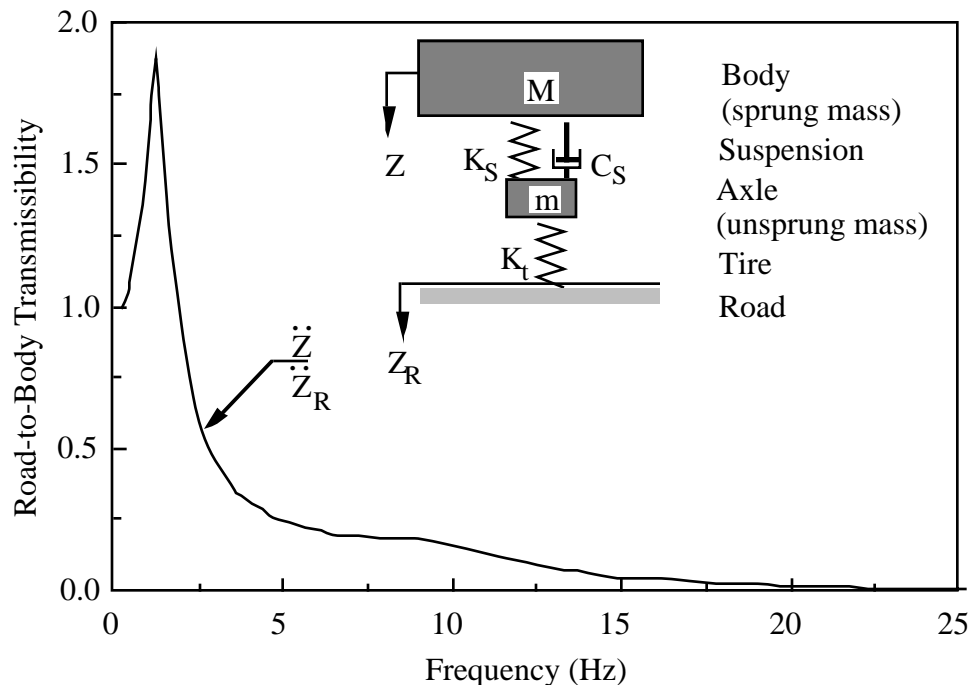

At very low frequency the body moves up and down exactly as does the ground. At about 1 Hz the body resonates on the suspension, amplifying the input from the road by a factor of 1.5-3.0 for typical cars. At higher frequencies the suspension absorbs the road inputs, isolating the body from the road. At about 10-15 Hz the wheel resonates, bouncing up and down with motions larger than provided by the road. This diminishes the isolation somewhat in this frequency range, but is an unavoidable phenomenon.

☞ A vehicle is a mechanical filter, with a frequency response function.

The “isolation” performance of a suspension is shown in the next figure. The road roughness acceleration spectrum on the left goes through the filter of the car’s suspension system to produce an acceleration spectrum on the car body as shown at the right. The plot in the middle is the frequency response of the vehicle, with the gain represented in units appropriate for PSDs.

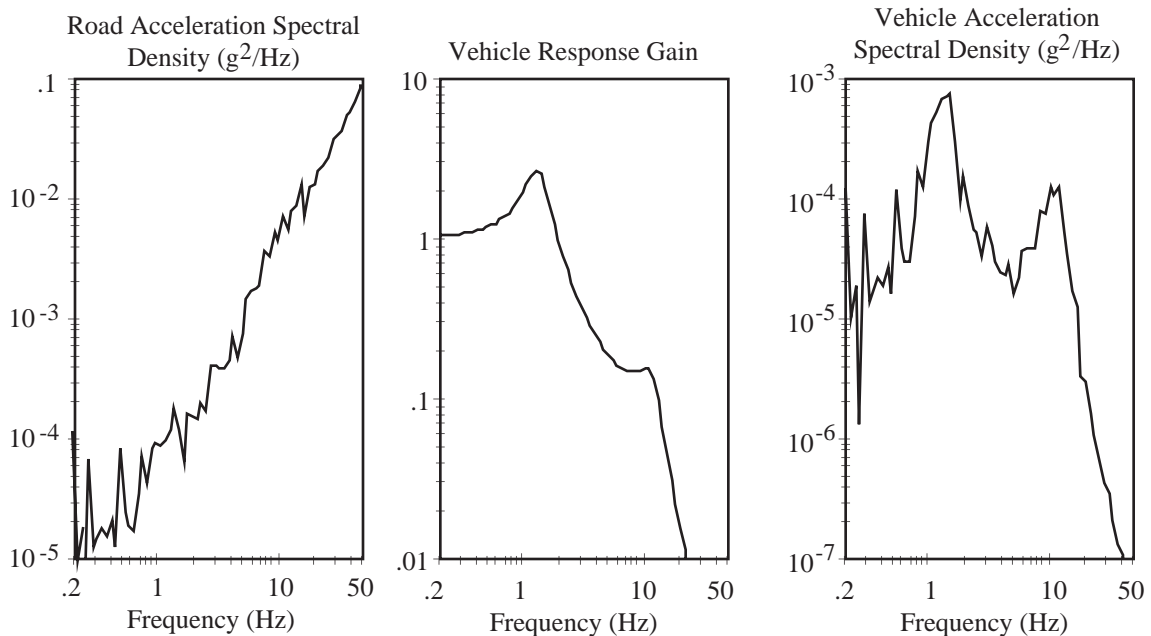

Although the acceleration input at about 1 Hz is amplified in the process, those above this frequency are strongly attenuated. The second acceleration peak around 10 Hz is due to wheel-hop resonance. Notice, however, how the isolation of the suspension reduces vibrations near 5 Hz—the frequency at which the human body is most sensitive to vertical acceleration.

☞ Are the dynamics of vehicle ride this simple?

Not quite. The quarter-car dynamics described above are basic to all vehicles and account for about 75% of the vibrations present on the vehicle. Four-wheel vehicle models that can pitch and roll add a little more to the picture, but generally cars can be “tuned” to keep these types of vibrations far less significant.

More important are the fore-aft inputs through the wheels and structural modes of the body that contribute to ride vibrations throughout the body of the car. These

contribute to the perceived ride quality of the vehicle, but are very specific to each model.

What Is Road Roughness?

By far, the main application for road profilers is to quantify road roughness.

☞ **There is not a single, standard definition of road roughness.**

Here is the American Society of Testing and Materials (ASTM) definition (E867):

“The deviations of a pavement surface from a true planar surface with characteristic dimensions that affect vehicle dynamics, ride quality, dynamic loads, and drainage, for example, longitudinal profile, transverse profile, and cross slope.”

This covers the factors that contribute to road roughness. However, it does not provide a quantitative definition or standard scale for roughness. It is also very broad, including qualities such as drainage and ride quality that are generally unrelated to each other.

☞ **Smoothness is a lack of roughness.**

Some engineers prefer to consider *smoothness* as a more optimistic view of the road condition. Because smoothness is a lack of roughness, you would have to first determine roughness and then transform the number. In America, the convention is to deal with roughness rather than smoothness.

For the traveling public, the concept of roughness is simple:

“I know it when I feel it.”

☞ **Some engineers think of roughness as the output of a specific device.**

Roughness has been of interest as long as there have been public roads. Old methods for measuring roughness are often thought of as standards by their users. Some of the instruments used in the past are described in the next section. Unfortunately, unless a roughness measure is based on profile, it cannot be reproduced. (Most of the devices considered as historical “standards” have either been discarded or lie rusting and abandoned in back lots.)

☞ **Roughness involves variation in surface elevation that induces vibrations in traversing vehicles.**

There are many kinds of vibration, ranging from sickening heaves due to long wavelengths, to the rapid teeth-jarring impacts and irritating noises caused by short wavelengths. Any road feature that causes an unwanted vehicle acceleration will be called “roughness” by persons concerned with that form of response.

☞ **Roughness is defined over an interval of profile.**

It is meaningless to talk about the roughness of a point. Instead, one must consider roughness as summary of deviations that occur over an interval between two points.

☞ **There are many types of roughness.**

Road users can identify different types of roughness, such as the various forms of unwanted vehicle vibration. It is reasonable to compute more than one roughness index from a profile, if the different indices provide independent information about the state of the road. Not all types of roughness are unique. Many of the roughness indices that have been calculated from profiles are so strongly correlated that one is statistically sufficient. It is of dubious utility to compute two indices that tell essentially the same thing.

☞ **Different types of roughness are associated with different wavelengths.**

For example, vehicle manufacturers are concerned with different aspects of ride, ranging from the heaving motions that mainly involve suspension movement, to audible noise involving acoustics of the body. These are caused by widely different wavelength ranges. (The vehicle body motions are due to wavelengths on the order of 15 meters, whereas the noise involves wavelengths shorter than 1 meter.)

Roughness analyses can be compared on the basis of how they process a sinusoid. Most of the analyses filter out very long wavelengths and very short wavelengths.

☞ **Roughness is not as easily identified as a single dimensional property.**

Length, weight, and other measures involve static physical properties of objects. Roughness involves at least two dimensions in a complex way: it involves variation of a profile height along its length. You cannot even speak of the roughness of a single profile point—it must be taken over some length.

Roughness is analogous to a sound level for noise. Although air pressure is a static property, noise level involves changes in air pressure over time. Measurement of noise has been standardized to the extent that we can buy inexpensive sound meters that combine the measurement of air pressure over time with a mathematical analysis (implemented electronically) to process the variations and produce a single output level. There are several standard analysis methods to choose from, that are selectable by a switch on the sound meter. The standards allow people who care about sound to communicate using measures with confidence that they will have the same meaning.

Maybe in a few years road roughness will be as standard as sound level.

What Are Response-Type Systems?

Although this book is about profilers, we must recognize that other types of systems have historically been used to define road roughness. Many engineers today have an intuitive concept of roughness that is based on the behavior of older systems.

As early as the 1920s, highway engineers installed devices in cars to record suspension stroke as a measure of roughness. These were called road meters and had several generic names, including: *response-type road roughness measuring systems* (RTRRMS), *response-type systems*, and *road meter systems*. In these systems, the vehicle is a passenger car, a van, a light truck, or a special trailer. A road meter is a transducer that accumulates suspension motions. Some of the popular brands were the Mays Ride Meter, the PCA meter, the Cox meter, and various home-made models.

Nearly all of the road meter designs follow the concept of the Bureau of Public Roads (BPR) Roughometer, and accumulate deflections of the vehicle suspension as it travels down the road. The BPR Roughometer is a single-wheel trailer with a one-way clutch mechanism that accumulates the suspension stroke in one direction. (The total stroke is twice that value.)

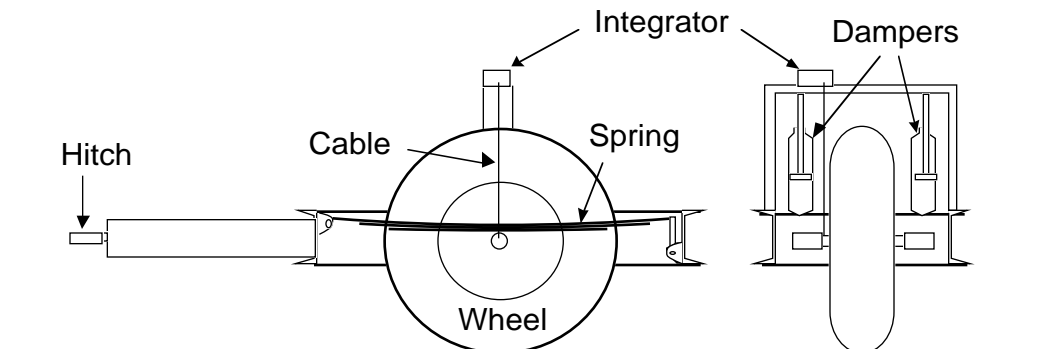

The BPR Roughometer.

Road meters are more commonly used in ordinary passenger cars, as shown in the next figure. The roughness measure that is obtained is “inches” of accumulated suspension stroke, normalized by the distance traveled. The measure is usually reported with engineering units such as in/mi or m/km, although sometimes arbitrary units are used based on the instrumentation hardware, e.g., “counts/mi.” Although not obvious, this measure of vehicle response is very similar in its frequency content to the accelerations on the vehicle body, so it is highly correlated to ride vibration.

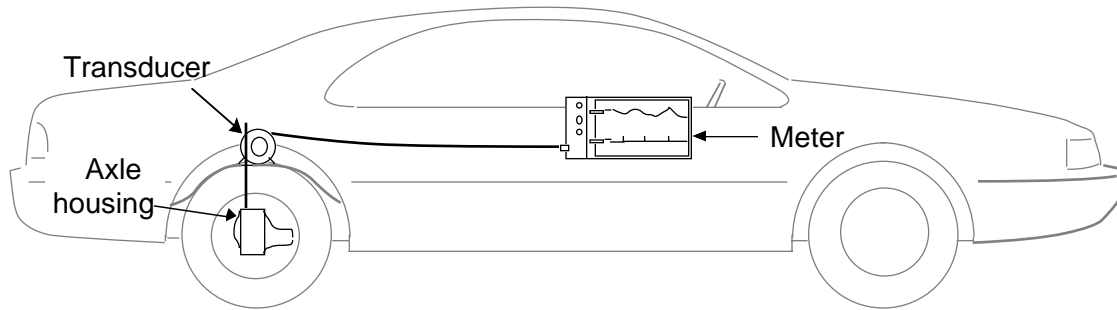

A car with a Mays meter.

☞ Measures from response-type systems are subject to each and every variable that influences vehicle response characteristics.

Even when the vehicle is standardized, differences remain between vehicles that you might think are identical. To further compound the problem, the response properties of the vehicles change with time. The fact that the response-type system depends on the dynamics of the host vehicle has two unwanted effects:

1. Roughness measuring methods have not been stable with time. Measures made today with road meters cannot be compared with confidence to those made several years ago.
2. Roughness measurements have not been transportable. Road meter measures made by one system are seldom reproducible by another.

These problems exist in part because the road meters are typically inventions devised to be inexpensive, rugged, and easy to use. A rigorous understanding of how they function together with a vehicle did not exist until 1980, when the variables were studied in a research project funded by the National Cooperative Highway Research Program (NCHRP).

☞ NCHRP Report 228 describes how response-type systems work.

A second source of difficulty involving response-type systems has been the lack of a standard roughness scale. With a standard roughness scale, some of the problems inherent in a response-type system can be overcome by calibration. The lack of a standard measure was at first not seen as a serious problem by many of the users of roughness instruments. Roughness data for a city, county, or State could have arbitrary units, so long as the data base was internally consistent. However, even the repeatability of the instruments was a problem.

☞ The “in/mi” measures from response-type systems are useful.

Although there are problems involving reproducibility and portability of data taken with response-type systems, one reason that they have been so popular for the past 50 years is that they work. The measures they produce have been viewed by engineers as matching their experience for determining pavement quality in a meaningful way. If they could be made to give results that were reproducible between

vehicles and over time, it is possible that there would not be as much interest in profiling methods today.

What Are the Frequency Responses of Roughness Measuring Devices?

The early roughness devices act as linear mechanical filters. Given a sinusoid as an input, they produce a sinusoid with the same wave number, which is then processed by the on-board instrumentation to produce a summary index.

☞ **Roughness measuring systems are band-pass or high-pass filters.**

We have already seen by example that an unfiltered profile is dominated by the slope of the road and long-wavelength undulations. Nearly all road roughness devices have functioned as mechanical filters, to remove the long wavelengths and focus on wavelengths that affect vehicle ride.

☞ **Low-speed rolling devices filter the profile through their geometry.**

Just as the wave numbers were normalized by the moving average base length, some of the plots that follow have wave number normalized by a characteristic dimension of the device.

The profilograph is a physical system that is actually close in concept to a high-pass moving average. The average is established by the many wheels, and deviations are measured relative to that average.

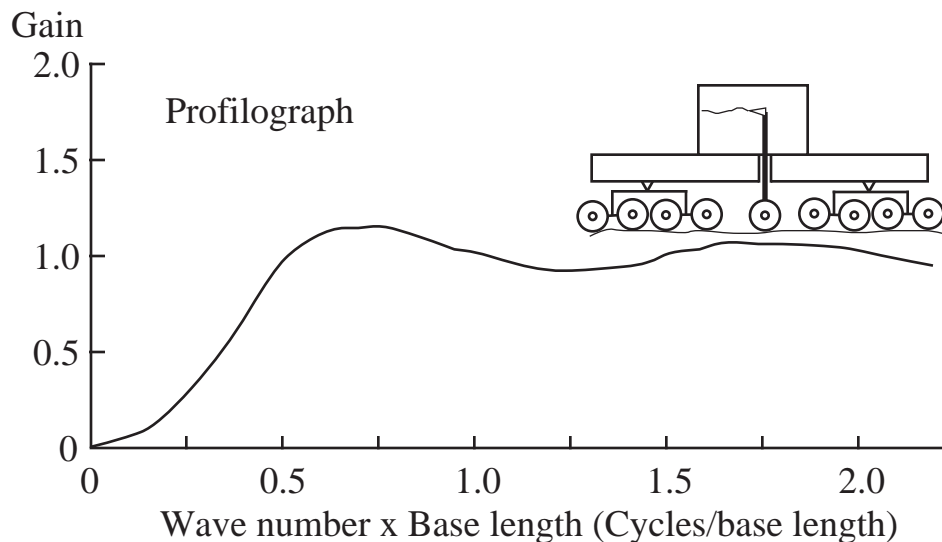

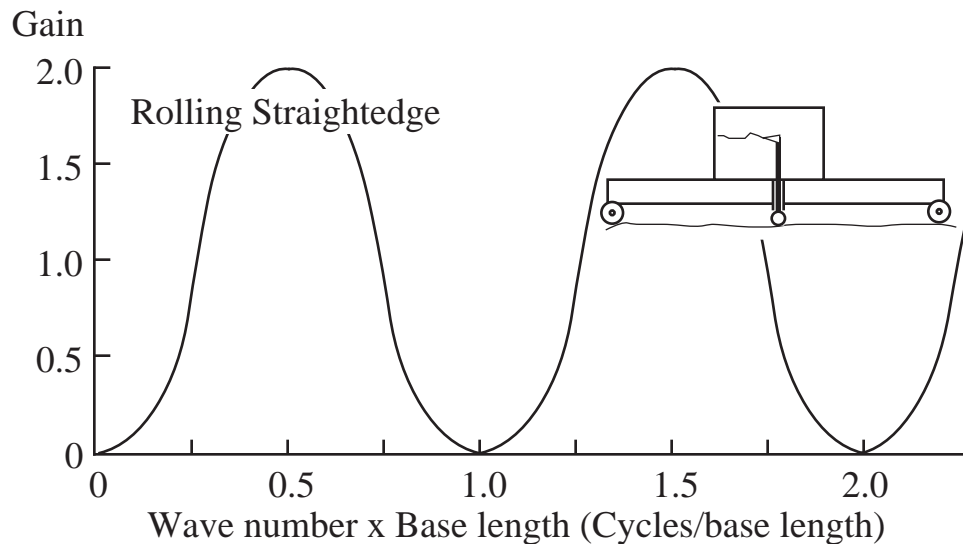
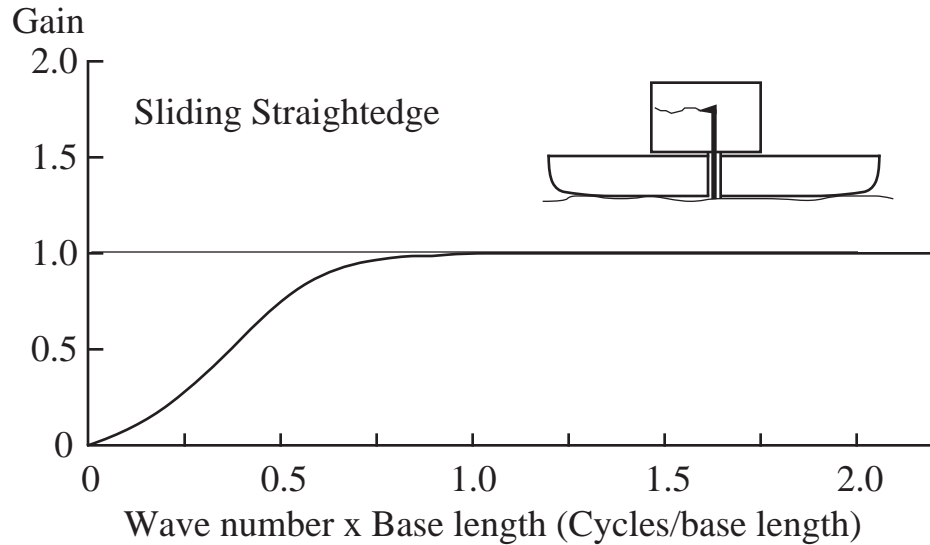

☞ **Response-type systems filter the profile through vehicle dynamics.**

As shown earlier, automobiles and other vehicle designed for the highway use suspensions and pneumatic tires to isolate the drivers and cargo from the high-amplitude accelerations associated with the road surface. The dynamics of the vehicle filter the input, amplifying the response at some frequencies, and attenuating it at others.

It turns out that the frequency response for the road meter input (velocity between the axle and body of the vehicle) is qualitatively very similar to that of the vertical acceleration of the body. Both the passenger acceleration and the road meter motion are affected in roughly equal parts by the body resonance (1 to 2 Hz) and the axle resonance (roughly 10-15 Hz), with some isolation near 5 Hz and for frequencies above 15 Hz.

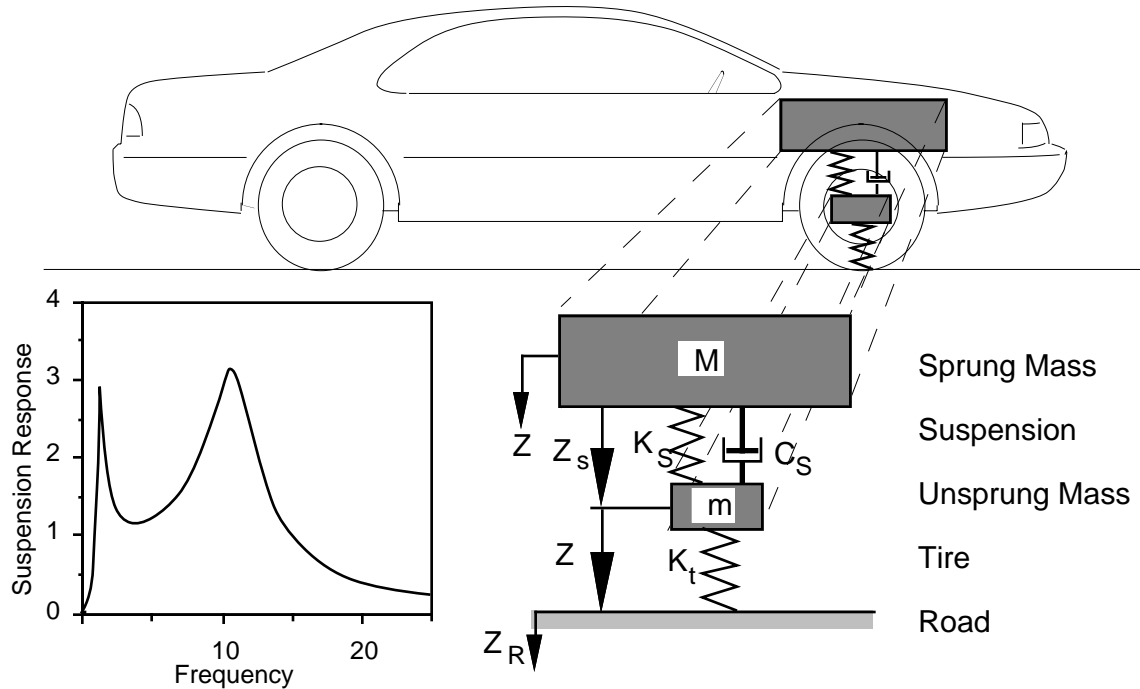

Unlike the low-speed devices, the filtering associated with a moving vehicle does not depend on geometry. Instead, it depends on time-based dynamics. The frequency response of a car is approximately independent of speed, when the frequency is defined in units of cycle/sec. However, if treated as a function of spatial frequency (wave number), then the response depends on speed, due to the relationship that

$$f = V v = \frac{V}{\lambda}$$

where f is frequency in cycle/sec, V is speed in ft/sec, v is wave number in cycle/ft, and λ is wavelength in ft/cycle.

What Is a Profile Index?

A profile measurement is a series of numbers representing elevation relative to some reference. There are thousands of numbers per mile of measured profile. There may be one, two, or more “slices” of the road profiled as you drive the profiler. In just a short time, you can literally accumulate millions of numbers. How can those millions of numbers be reduced to provide information you can use?

 **A profile index is a summary number calculated from the many numbers that make up a profile.**

Details of the calculation determine the significance and meaning of the index. The number might be related to the motion of a mathematical vehicle model, a summary of

grinding requirements, some index used in the past, or to an abstract concept of roughness. Or, it might not be linked to anything at all.

 **The calculated index is only valid if the profile data is valid.**

If the profiler is not functioning correctly, or is not suited for the index of interest, it is not possible to get the same numerical value that would be obtained from the true profile. Not every profiler is capable of measuring every possible roughness index. The accuracy of a calculated index is ultimately limited by errors in the measured profile.

 **There is a true value for any given index.**

The true value of an index is the value that would be obtained by applying the calculation method to the true profile.

 **A profile index is portable and reproducible.**

If an index can be calculated from the true profile, then the property it represents can be measured by any valid profiler. Thus, a profile-based index is portable—it can be measured by different types of profiler instruments, so long as they are valid for that index.

Some profile analyses are not as portable as others. For example, if an analysis requires a specific sample interval, a profiler is valid for its calculation only if the sample interval matches.

 **A profile index is stable with time.**

Because the concept of a true profile has the same meaning from year to year, it follows that a mathematical transform of the true profile is also stable with time.

 **All roughness indices in use are calculated with a basic 4-step method.**

The mathematical transforms used to compute almost any profile roughness index can be organized into four steps. Details of the calculations done in each step define the index. The steps are as follows.

1. How many profiles are needed to capture the surface conditions of interest?

Most indices are calculated from a single profile. If your profiler measures the profile of the left and right-hand wheel tracks in a lane, then you can get separate roughness indices for each. However, some indices require two profiles.

2. How is the profile filtered?

All profile-based roughness indices that are now in use involve at least one filter, to “filter out” wavelengths that are not of interest. Some analyses involve several filters applied in sequence.

3. How is a filtered profile accumulated (and reduced)?

The sequence of transformed numbers must be reduced to a single index. This is commonly done by accumulating the absolute values of the numbers, or accumulating the squared values. The result is a single cumulative number.

4. How is the summary number scaled?

The final step is to convert the accumulated number to an appropriate scale. This nearly always involves dividing by the number of profile points or the length of the profile, to normalize the roughness by the length covered. For example, many historical roughness indices have had units of inches/mile. A scale factor may be used to obtain standard units. A transformation equation may be used to convert from a profile-based scale to an arbitrary scale.

 **Many roughness indices can be calculated from a single profile.**

An advantage of using profilers to determine roughness, besides the portability, is flexibility. You can obtain several statistics from the same profile. Each statistic can potentially describe a different characteristic of the profile.

What Is the IRI?

Almost every automated road profiling system includes software to calculate a statistic called the International Roughness Index (IRI). Through the Road Profiler User Group (RPUG) and the Federal Highway Administration (FHWA) Highway Performance Monitoring System (HPMS), profiler users have shared experiences measuring IRI. IRI measures from different States are largely compatible. Even IRI measures from different countries can be compared directly.

Background

 **The IRI is a continuation of the “in/mi” roughness statistic in use since the automobile was developed.**

Although the “in/mi” measure from response-type systems has been popular since the 1940’s, it was not possible to obtain the same values from different vehicles, or even from the same vehicle over time. A number of States requested research, and in the late 1970’s the systems were studied under the National Cooperative Highway Research Program (NCHRP). The results were reported in NCHRP Report 228.

 **Most of the research underlying the IRI is in NCHRP Report 228.**

In order to calibrate the response-type systems, an ideal system was defined for the computer. Mathematical models of the vehicle and road meter were developed and tested, and shown to provide the same type of “in/mi” index as mathematical function of the longitudinal profile.

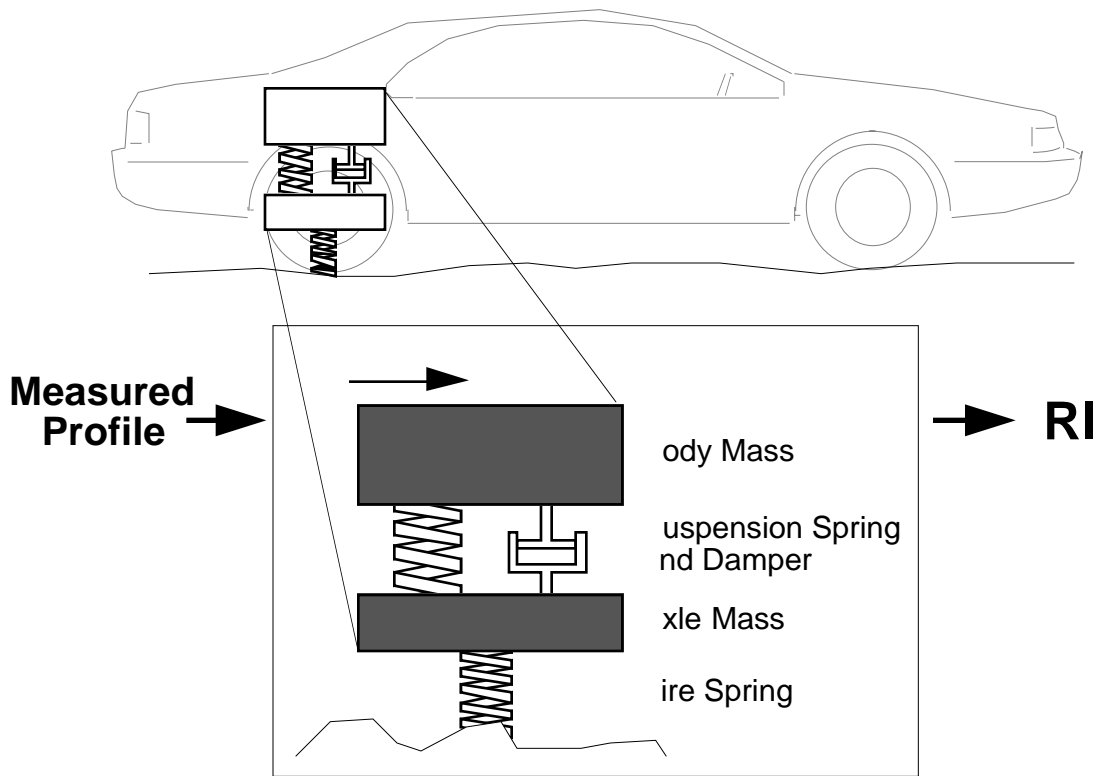

Computer Algorithm

Because response-type road roughness measuring systems were common, the profile index was tailored to correlate well with the output of these systems. The filter is based on a mathematical model called a quarter-car. The quarter-car filter calculates the suspension deflection of a simulated mechanical system with a response similar to a passenger car. The simulated suspension motion is accumulated and divided by the distance traveled to give an index with units of slope (m/km, in/mi, etc.). The form of data reduction emulates a perfect road meter.

The NCHRP research led to specific set of parameters for a quarter-car computerized response system, called *The Golden Car*. The name was intended to convey that this computer representation was a calibration reference, such as a 1.0000-m gold bar kept in a vault and brought out once in a while to calibrate other length measures.

The IRI is essentially a computer-based “virtual response-type system.” Several years of research reported in NCHRP Report 228 were spent to develop a profile index that built on the 50 years of experience accumulated by the States and others using “in/mi” roughness indices.

👉 Development and testing of the IRI was continued by The World Bank.

The World Bank sponsored several large-scale research programs in the 1970’s that investigated some basic choices facing developing countries: should the governments borrow money to build good, expensive roads, or should they save money with poor, cheap roads? It turns out that poor roads are also costly to the

country as a whole, due to user costs such as damage to vehicles. Road roughness was identified as a primary factor in the analyses and trade-offs involving road quality vs. user cost. The problem was, roughness data from different parts of the world could not be compared. Even data from the same country were suspect because the measures were based on hardware and methods that were not stable over time.

In 1982, the World Bank initiated a correlation experiment in Brazil to establish correlation and a calibration standard for roughness measurements. In processing the data, it became clear that nearly all roughness measuring instruments in use throughout the world were capable of producing measures on the same scale, if that scale were suitably selected. A number of methods were tested, and the “in/mi” calibration reference from NCHRP Report 228 was found to be the most suitable for defining a universal scale.

Several years of additional development were spent testing computation methods for a variety of profiling methods and step sizes. Example computer algorithms were published, and guidelines were written, reviewed, and published to define a reference measure that was called the International Roughness Index (IRI). The guidelines published by The Bank explained how to measure IRI with a variety of equipment.

☞ **The IRI is reproducible, portable, and stable with time.**

The IRI was the first widely used profile index where the analysis method is intended to work with different types of profilers. IRI is defined as a property of the true profile, and therefore it can be measured with any valid profiler. The analysis equations were developed and tested to minimize the effects of some profiler measurement parameters such as sample interval.

☞ **The IRI is a general pavement condition indicator.**

The IRI summarizes the roughness qualities that impact vehicle response, and is most appropriate when a roughness measure is desired that relates to: overall vehicle operating cost, overall ride quality, dynamic wheel loads (that is, damage to the road from heavy trucks and braking and cornering safety limits available to passenger cars), and overall surface condition. The following figure shows IRI ranges represented by different classes of road.

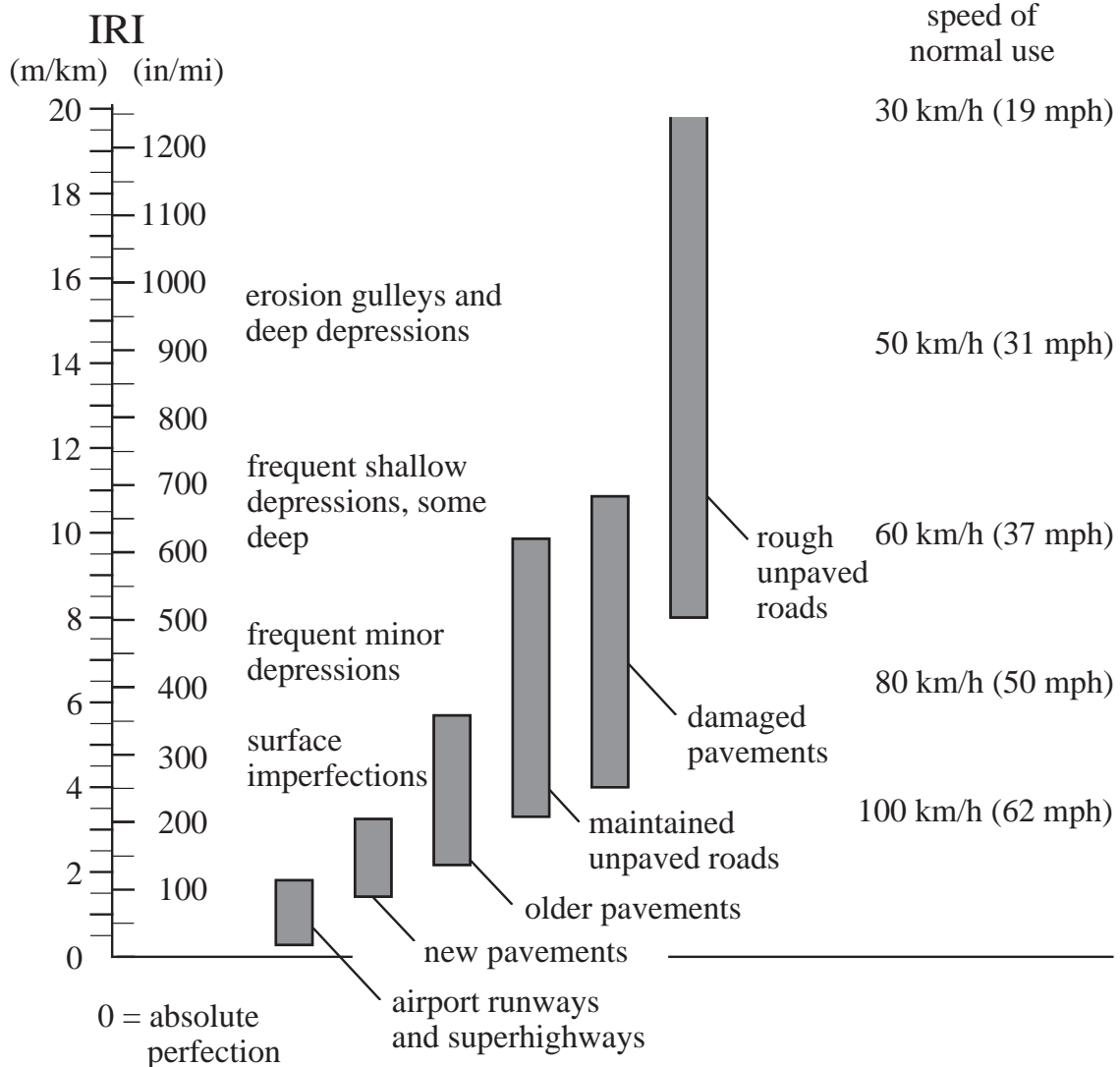

Properties of the IRI Analysis

The quarter-car model used in the IRI algorithm is just what its name implies: a model of one corner (a quarter) of a car. The model is shown schematically in an earlier figure: it includes one tire, represented with a vertical spring, the mass of the axle supported by the tire, a suspension spring and a damper, and the mass of the body supported by the suspension for that tire.

☞ The quarter-car model was tuned to maximize correlation with response-type road roughness measuring systems.

This quarter-car simulation is meant to be a theoretical representation of the response-type systems in use at the time the IRI was developed, with the vehicle properties of the “golden car” adjusted to obtain maximum correlation to the output of those systems. Considerations in its design are described in NCHRP Report 228.

The golden-car parameters give the quarter car a behavior typical of most highway vehicles with one exception: the damping is higher than most cars. This keeps the IRI from “tuning in” to certain wavelengths and degrading correlation with other vehicles. The figure below shows how IRI values from profile data relate to raw measures from a response-type system.

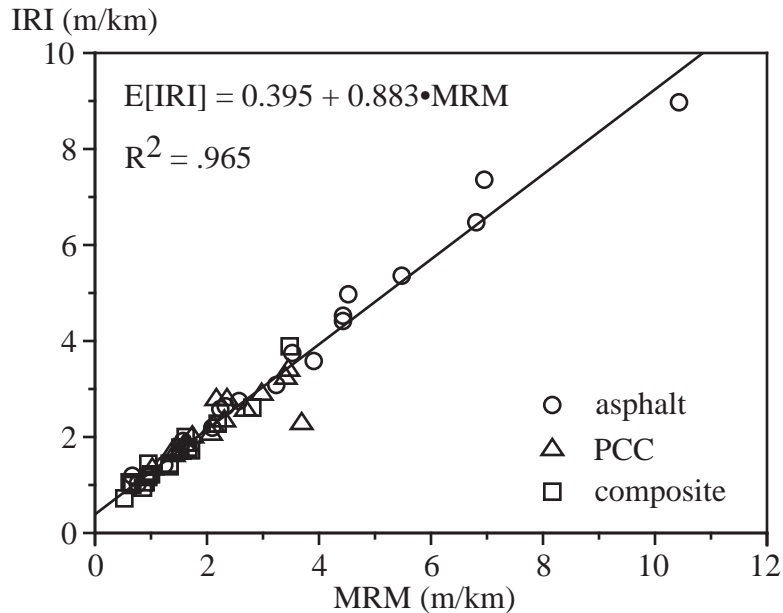

☞ The IRI describes profile roughness that causes vehicle vibrations.

The response of the IRI to sinusoids is intentionally very similar to measured physical responses of highway vehicles. It was mainly developed to match the responses of passenger cars, but subsequent research has shown good correlation with light trucks and heavy trucks. The IRI has become recognized as a general-purpose roughness index that is strongly correlated to most kinds of vehicle response that are of interest. Specifically, IRI is very highly correlated to three vehicle response variables that are of interest:

1. road meter response (for historical continuity),
2. vertical passenger acceleration (for ride quality), and
3. tire load (for vehicle controllability and safety).

The IRI is not related to all vehicle response variables. For example, it does not correlate well with vertical passenger position, or axle acceleration.

The fact that IRI correlates well with both road meter response and passenger acceleration is no coincidence; the correlation between road meter response and passenger acceleration was certainly a factor in the decades of acceptance of the road meter as a useful tool for measuring roughness.

☞ **IRI is influenced by wavelengths ranging from 1.2 to 30 meters.**

The wave number response of the IRI quarter-car filter is shown in the next figure. The amplitude of the output sinusoid is the amplitude of the input, multiplied by the gain shown in the figure. The gain shown in the figure is dimensionless. Thus, if the input is a sinusoid with an amplitude that is slope, the output is the product of the input amplitude and the value taken from the plot.

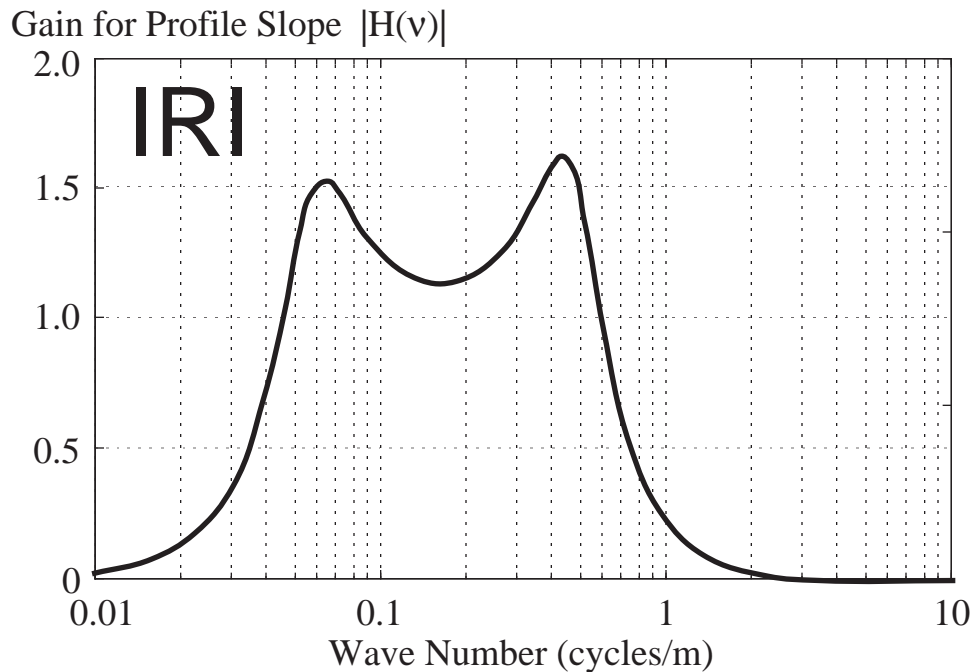

The IRI filter has maximum sensitivity to slope sinusoids with wave numbers near 0.065 cycle/m (a wavelength of about 15 m) and 0.42 cycle/m (a wavelength of about 2.4 m). The response is down to 0.5 for 0.033 and 0.8 cycle/m wave numbers which correspond to wavelengths of 30 m and about 1.25 m, respectively. However, there is still some response for wavelengths outside this range.

☞ **The IRI scale is linearly proportional to roughness.**

If all of the elevation values in a measured profile are increased by some percentage, then the IRI increases by exactly the same percentage. An IRI of 0.0 means the profile is perfectly flat. There is no theoretical upper limit to roughness, although pavements with IRI values above 8 m/km are nearly impassable except at reduced speeds.

☞ **The IRI was the first highly portable roughness index that is stable with time.**

The IRI is not the first profile-based roughness index. When it was introduced, profilers from different countries and different manufacturers were each used with profile analyses developed for their specific hardware. Most of the analyses were not intended to work with true profile. Those that did had specific requirements for the

interval between elevation measures, and gave significant errors when applied to profiles that had a different interval.

The software published by The World Bank was tested by new users, who found that under controlled research tests, they could obtain nearly identical IRI values using different profilers.

Definition of the IRI

The above descriptions of the IRI background and properties are intended to give an idea of what the IRI computer software is intended to simulate, and how you can interpret the IRI scale. However, the IRI is rigorously defined as a specific mathematical transform of a true profile. The specific steps taken in the computer program to compute IRI are listed below.

The IRI is calculated for a single profile.

If your profiler measures several profiles simultaneously, then you can get the IRI for each. The IRI standard does not specify how you locate the line on a road that defines the profile. Any possible line on the ground has an associated IRI statistic.

The standard does not specify how you combine IRI values for different profiles taken for the same road. They can be averaged, but the result is not IRI—it is the average of several IRI's.

The profile is filtered with a moving average with a 250-mm (9.85-in) base length.

The moving average is a low-pass filter that smoothes the profile. The computer program does not apply the filter unless the profile interval is shorter than 167 mm (6.6 in).

The 250-mm moving average filter should be omitted for profiles obtained with some systems.

This step should be omitted if (1) the profile has already been filtered by a moving average or with an anti-aliasing filter that attenuates wavelengths shorter than 0.5 m, and (2) the sample interval is less than 167 mm (6.6 in). For example, Profilometers by K.J. Law detect elevation values at intervals of 25 mm, apply a 300-mm moving average filter, and store the result at 150 mm intervals. The filter used prior to storing the profile is identical to the one used in the IRI (for a 150-mm sample interval), and therefore the moving average in the IRI should not be applied a second time.

The profile is further filtered with a quarter-car simulation.

The quarter-car parameters are specified as part of the IRI statistic, and the simulated travel speed is specified as 80 km/hr (49.7 mi/hr). The Golden Car parameters are:

$$\frac{k_s}{m_s} = 63.3 \quad \frac{k_t}{m_s} = 653 \quad \frac{c}{m_s} = 6 \quad \frac{m_u}{m_s} = 0.15$$

where k_s is the spring rate, m_s is the sprung mass, k_t is the tire spring rate, c is the damper rate, and m_u is the unsprung mass.

The output of the filter represents suspension motion of the simulated quarter car.

☞ **The filtered profile is accumulated by summing absolute values and then is divided by the profile length.**

The resulting IRI statistic has units of slope. As a user, you can express the slope in any appropriate units. The most common choices are in/mi (multiply slope by 63,360) and m/km (multiply slope by 1000).

☞ **Details of the IRI are handled in computer software.**

The above summary illustrates how the IRI fits the earlier description of a generic profile index. The analysis is applied to a single profile, the profile is filtered (twice), the filtered result is accumulated, and finally divided by the length of the profile. The IRI is linearly related to variations in profile, in the sense that if all of the elevation values in the profile are doubled, the resulting IRI will also be doubled.

A reference for more information about the IRI calculation method is:

M. W. Sayers, "On the Calculation of International Roughness Index from Longitudinal Road Profile," *Transportation Research Record 1501*, (1995) pp 1-12.

☞ **Free computer software is available for computing IRI.**

Fortran source code is available on the Internet for use by developers. The analysis is also included in a free Windows package called RoadRuf. The RoadRuf software and example source code can be found at:

<http://www.umtri.umich.edu/erd/roughness/rr.html>

What Are Panel Ratings?

In 1960, F.N. Hveem noted, "Ever since roads and highways have been constructed, the people who use them have been keenly aware of the relative degrees of comfort or discomfort experienced in traveling." Long before high-speed profiling technology existed, engineers have attempted to estimate the general opinion of the traveling public of specific roadways. Perhaps the most direct method is to drive people over sections of road and ask them what they think.

☞ **Panel ratings are subjective.**

Ratings from people reflect their opinions and are subjective. Besides reflecting the condition of the road, the rating from a person is influenced by his or her standards, beliefs, and mood at the time the opinion is given. In contrast, measures obtained from analysis of profile data are considered to be objective.

☞ **Subjective rating scales for roads usually go from 0 to 5.**

The next figure shows a rating form in which a person rates a road on a scale of 0 to 5. The 0 to 5 scale was used for a large-scale road test conducted by AASHO in the 1950's, in which roads were subjected to mixed traffic and researchers tracked the condition of the pavement. A panel of pavement experts made their best evaluations of the conditions of the test pavements based on close inspection, the experience of driving over them, and the use of measures taken from several instruments in use at the time.

Acceptable ?

Yes

No

Undecided

5
4 Very Good
3 Good
2 Fair
1 Poor
0 Very Poor
Rating

Section Identification _____

Rater _____ Date _____ Time _____ Vehicle _____

☞ **Ratings from the original AASHO test were called PSR.**

The ratings from the panel of experts were processed to assign a single number to each pavement that represented its *serviceability*, defined as:

“... the ability of a specific section of pavement to serve high-speed, high-volume, mixed (truck and automobile) traffic in its existing condition.”

The summary number was called *present serviceability rating (PSR)*. The researchers also asked persons who were not engineers to rate the pavements. Nearly the same results were obtained.

The current meaning of PSR is not standard. Some engineers consider PSR to be a one-of-a-kind measure that applied only for the tests done in the 1950's. Since the numbers were based on human opinion at the time, there is no way to confirm or deny the relation of ratings taken today with the original PSR scale. With this concept, the scale can no longer be used.

Other engineers use the name PSR to refer to any study in which ratings are taken for roads on a 0 to 5 scale.

 **Predictions of PSR were called PSI.**

In addition to the rankings obtained from the panel of raters in the original AASHO tests, several measures were taken of the pavements with instruments in use at the time. Using the instrument measures, PSR could be estimated using an equation obtained from statistical analyses of the data. The estimate of the present serviceability rating (PSR) was called the *present serviceability index* (PSI).

 **Statistical processing is used to calculate mean panel rating (MPR).**

Past research has shown that opinions of a single person tend to be unreliable, relative to objective measures, and also relative to opinions of other persons. However, when a group of ratings are taken together, the average rating can be fairly consistent. After statistical processing, the results are processed to yield a single rating for the panel as a whole, typically called mean panel rating (MPR). In most studies, ratings are re-scaled before being averaged. Thus, the MPR is not necessarily the mean value of the original ratings of the panel members.

We see this everyday, in the nature of opinion polls where a small group of people are surveyed to indicate the opinions of a larger part of the population.

Panel rating experiments are designed with the intent of estimating the opinion of “the public” from the small group composing the panel. A typical panel size is about 30, but reasonable results can be obtained with smaller groups. In the period of time since the AASHO Road Test was conducted, the panel rating concept has evolved considerably. Statistical distortions in the rating scale have been identified such as central tendency, error of leniency, and others. Statistical analysis methods have been established for minimizing their effects.

 **Subjective ratings depend on questions and instructions.**

Subjective panel ratings depend strongly on the instructions given to the members of the panel to define what physical property or quality is being judged. The instructions must “train” the rater. Yet, in a research program, the physical properties are not fully known—that may be the point of the research. The NCHRP sponsored two research projects in the 1980’s to develop a methodology for obtaining valid ratings, resulting in the concept of ride number described in the next section. However, even today, procedures are not standard for obtaining panel ratings.

 **Mean Panel Ratings are not practical for network use.**

There are two problems with using MPR data directly for evaluating the state of a road network:

1. The rating scale is not a measure of road condition that is stable with time. For example, roads considered “good” by a panel today might be considered something else by a panel 50 years from now.
2. It is expensive to obtain panel ratings due to the number of people required, and the need to transport them to the roads being rated.

What Is Ride Number?

For decades, highway engineers have been interested in estimating the opinion of the traveling public of the roughness of roads. The PSI scale from the AASHO Road Test has been of interest to engineers since its introduction in the 1950's. Ride number is a profile index intended to indicate rideability on a scale similar to PSI.

Background

Direct collection of subjective opinion in the form of mean panel rating is too expensive, and provides no continuity from year to year.

Ride Number is the result of NCHRP research in the 1980's.

The National Cooperative Highway Research Program (NCHRP) sponsored two research projects by Dr. Michael Janoff in the 1980's that investigated the effect of road surface roughness on ride comfort, as described in NCHRP Reports 275 and 308. The objective of that research was to determine how features in road profiles were linked to subjective opinion about the road from members of the public. During two studies, spaced at about a 5-year interval, mean panel ratings (MPR) were determined experimentally on a 0-to-5 scale for test sites in several States. Longitudinal profiles were obtained for the left- and right-hand wheel tracks of the lanes that were rated.

At the time that the NCHRP studies were performed, the IRI was not well known. However, the researchers investigated a quarter-car analysis nearly identical to IRI, and found significantly less correlation between the quarter-car index and panel rating than between a profile index based on short wavelengths. (Subsequent studies have shown that higher correlation is obtained with IRI if an appropriate nonlinear transform is made.)

Profile-based analyses were developed to predict MPR. A method was developed in which PSD functions were calculated for two longitudinal profiles and reduced to provide a summary statistic called PI (profile index). The PI values for the two profiles were then combined in a nonlinear transform to obtain an estimate of MPR.

Ride Number (RN) is an estimate of Mean Panel Rating.

The mathematical procedure developed to calculate RN is described in NCHRP Report 275, but not in complete detail. Software for computing RN with the PSD method was never developed for general use.

In 1995, some of the data from the two NCHRP projects and a panel study conducted in Minnesota were analyzed again in a pooled-fund study initiated by the Federal Highway Administration. The objective was to develop and test a practical mathematical process for obtaining RN. The method was to be provided as portable software similar to that available for the IRI, but for predicting MPR rather than IRI. The profile data in the original research were obtained from several instruments. Most

were measured with a K.J. Law Profilometer owned by the Ohio Department of Transportation, and are thought to be accurate. A few other test sites were profiled with instruments whose validity has been questioned. The new analyses were limited to 140 test sites that had been profiled with the Ohio system.

A new profile analysis method was developed that is portable. The software was tested on profiles obtained from different systems on the same sites, and similar values of RN were obtained. It predicts MPR slightly better than previously published algorithms. The figure below shows the correlation for the new RN. For comparison, the figure shows a correlation involving a transform of IRI.

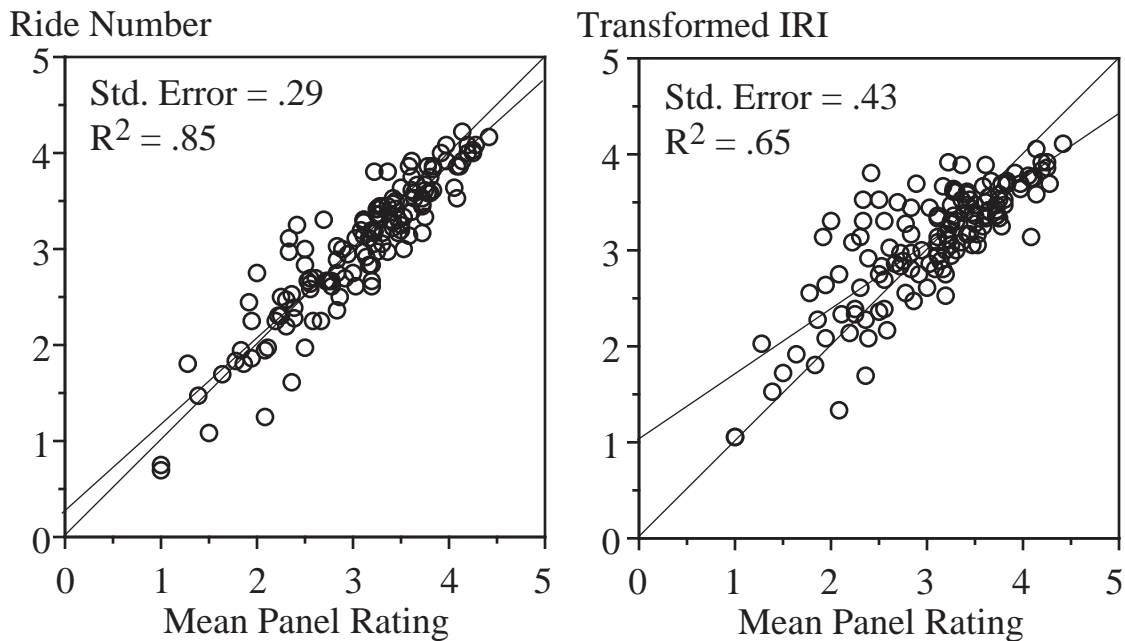

Correlation between Ride Number and MPR.

Properties of the Ride Number Analysis

The new ride number analysis method shares features with the IRI. It uses the same filtering method, which has been demonstrated to work with sample intervals ranging from zero up to about one foot.

Ride Number uses the 0 to 5 PSI scale.

The 0 to 5 scale for present serviceability was used because it is so familiar to the highway community. However, the methods used in the NCHRP research were not the same as used in the older tests. (The newer methods are based on a better understanding of psychological scaling than existed when the early tests were done.)

Ride Number is a nonlinear transform of a statistic called PI.

Keeping with the naming convention of Janoff and others, the profile index used in the ride number analysis is called PI, for “profile index.” Like other profile indices,

PI generally ranges from 0 (a perfectly smooth profile) to positive values proportional to a type of roughness. PI is transformed to a scale that goes from 5 (perfectly smooth) to 0 (the maximum possible roughness). The experimental data validate the scale for values from 1 to 4.5.

The choice of scale creates a highly nonlinear relationship between profile variations and RN. If the RN is known for a profile, and the values of elevation are all doubled to increase roughness by a factor of 2, the RN will go down. However, the amount that RN decreases cannot be determined simply.

☞ Nonlinearity limits some applications of Ride Number.

The nonlinearity poses no problem for the collection of roughness information to describe the condition of a road network. For roughness collected on a per-mile basis (or any standard length), profile indices are converted to the 0-to-5 scale and entered into the data base.

Some advanced capabilities of the IRI, such as the roughness profiles that will be shown later, are difficult to apply. The problem is that RN values for adjacent sections of profile cannot be averaged in the same way as IRI. For example, if one mile has an RN value of 3 and the next has an RN of 4, the RN for the two-mile segment is not 3.5. (It is about 3.37.)

☞ PI and RN are sensitive to shorter wavelengths than the IRI.

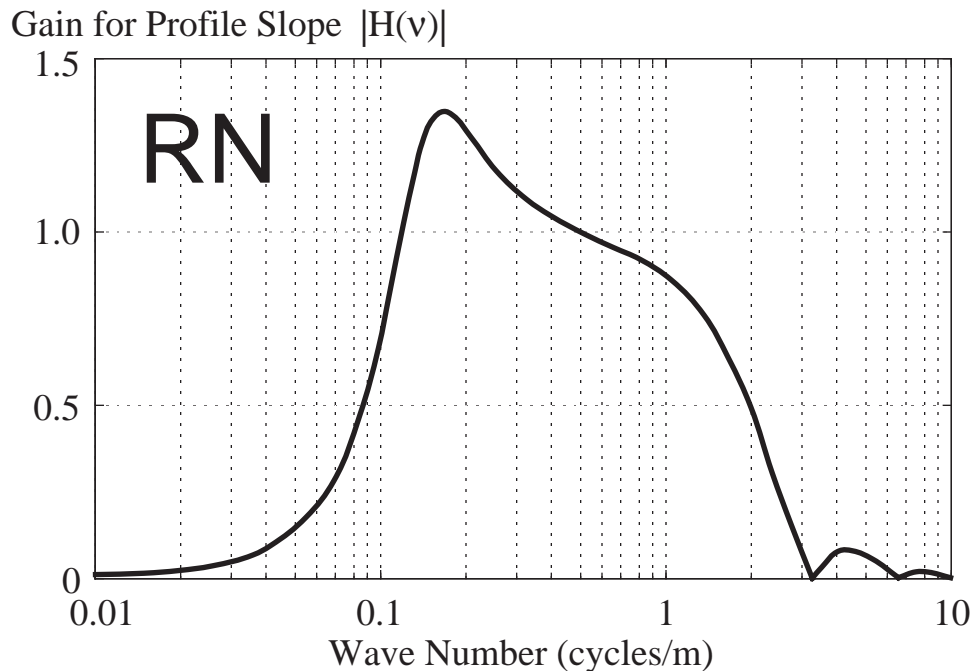

The above figure shows the sensitivity of PI. As in the earlier section on IRI, this shows the response of the profile index for a slope sinusoid. If given a sinusoid as input, the PI filter produces a sinusoid as output. The amplitude of the output sinusoid is the amplitude of the input, multiplied by the gain shown. The maximum

sensitivity is for a wave number of 0.164 cycle/m (0.05 cycles/ft), which is a wavelength of about 6 meters (20 ft). Recall that the IRI had great sensitivity to sinusoids with a wavelength of 16 meters (wave number of 0.065 cycle/m). The figure shows that the ride number analysis has a low sensitivity to that wavelength and even lower sensitivity for longer wavelengths.

☞ Ultrasonic profilers are not valid for obtaining ride number.

Ride Number is portable, but not as much as the IRI. Although we do not yet have the experience with RN as we do with IRI, research to date shows that most profiles obtained with ultrasonic systems give incorrect results. The PI values are too high, leading to RN values that are too low.

☞ Ride Number is correlated to IRI but the two are not interchangeable.

The content of a road profile that affects RN is different than the content that affects IRI. Each provides unique information about the roughness of the road, although there is correlation. For example, the next figure shows the correlation between IRI and the PI statistic used to determine RN.

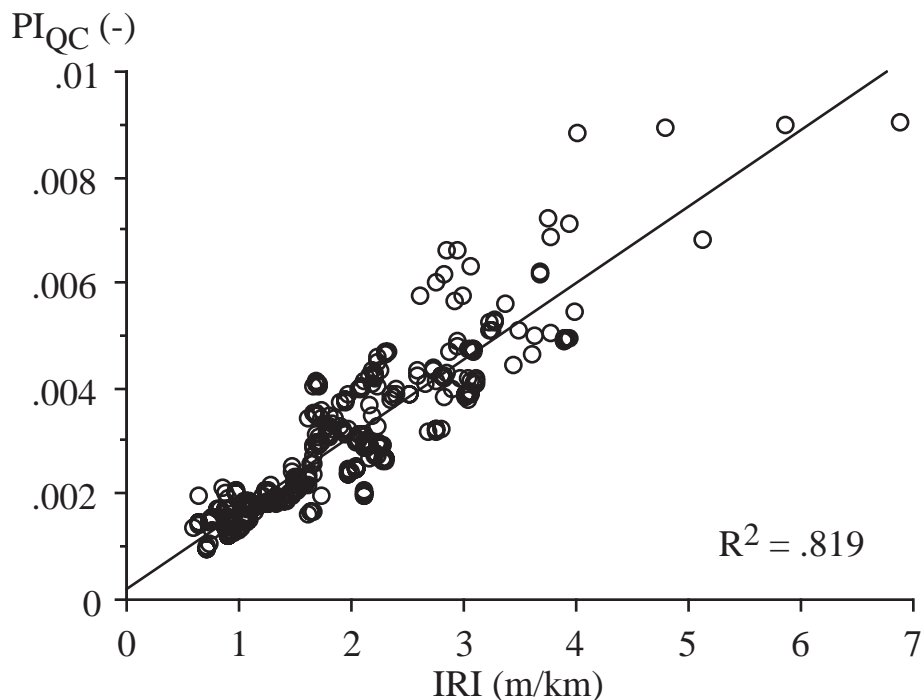

Correlation between PI (used to define RN) and IRI.

Definition of Ride Number

The above descriptions of the RN background and properties are intended to give an idea of how to interpret the RN scale. As implemented in new software, RN is rigorously defined as a specific mathematical transform of a true profile. The specific steps taken in the computer program to compute RN are listed below.

☞ Ride Number is calculated from one or two profiles.

Ride Number is ideally calculated from the profiles in the left and right wheelpaths of automobiles. Each profile is processed independently and the results are combined in the last step. RN can also be calculated for a single profile if only one is available.

☞ The profile is filtered with a moving average with a 250-mm (9.85-in) base length.

The moving average is a low-pass filter that smoothes the profile. The computer program does not apply the filter unless the profile interval is shorter than 167 mm (6.6 in).

☞ The 250-mm moving average filter should be omitted for profiles obtained with some systems.

This step should be omitted if (1) the profile has already been filtered by a moving average or with an anti-aliasing filter that attenuates wavelengths shorter than 0.5 m, and (2) the sample interval is less than 167 mm (6.6 in). For example, Profilometers by K.J. Law detect elevation values at intervals of 25 mm, apply a 300-mm moving average filter, and store the result at 150 mm intervals. The filter used prior to storing the profile is identical to the one used in RN (for a 150-mm sample interval), and therefore the moving average in the RN should not be applied a second time.

☞ The profile is further filtered with band-pass filter.

The filter uses the same equations as the quarter-car model in the IRI. However, different coefficients are used to obtain the sensitivity to wave number shown in the last figure. The quarter-car parameters for the RN filter are:

$$\frac{k_s}{m_s} = 390 \quad \frac{k_t}{m_s} = 5120 \quad \frac{c}{m_s} = 17 \quad \frac{m_u}{m_s} = 0.036$$

☞ The filtered profile is reduced to give PI.

The filtered profile is reduced to yield a root-mean-square (RMS) value called PI, that should have units of dimensionless slope (ft/ft, m/m, etc.).

☞ PI is transformed to RN.

RN is defined as an exponential transform of PI according to the equation:

$$RN = 5e^{-160(PI)}$$

If a single profile is being processed, its PI is transformed directly. If two profiles for both the left and right wheel tracks are processed, values for the two are averaged with the following equation, and then the transform is applied.

$$PI = \sqrt{\frac{PI_L^2 + PI_R^2}{2}}$$

☞ Details of Ride Number are handled in computer software.

The above summary illustrates how the RN fits the earlier description of a generic profile index. The analysis is applied to two profiles, the profile is filtered (twice), the filtered result is accumulated, and cast onto the familiar PSI scale.

A reference for more information about RN is:

Sayers, M.W. and Karamihas, S.M., "Estimation of Rideability by Analyzing Longitudinal Road Profile." *Transportation Research Record 1536*, (1996) pp 110-116.

The entire development is described in:

Sayers, M.W. and Karamihas, S.M., "Interpretation of Road Roughness Profile Data." Federal Highway Administration Report FHWA RD-96-101.

 **Free computer software is available for computing RN.**

Fortran source code is available on the Internet for use by developers. The analysis is also included in a free Windows package called RoadRuf. The RoadRuf software and example source code can be found at:

<http://www.umtri.umich.edu/erd/roughness/rr.html>

What Other Roughness Indices Are In Use?

Only a few profile analyses are described in detail in this little book: moving average, PSD, IRI, and RN. However, as noted earlier, there is an unlimited number of analyses that can potentially be applied. Most analyses that have been tried in the past have not received broad acceptance for one of two reasons:

1. They are not widely available in the form of software that works with profiles obtained with equipment from different manufacturers.
2. They correlate so highly with IRI that there is little reason to use them, if IRI is already being calculated.

 **Half-car Roughness Index (HRI) is the IRI algorithm applied to the average of two profiles.**

Prior to the development of the IRI, vehicle simulation was used with measured profiles to calibrate response-type systems. The response of a half-car model can be obtained with the same equations as used for the quarter car. The trick is to take a point-by-point average of the two profiles (one from the left wheeltrack and one from the right wheeltrack) first, and then process the averaged profile with a quarter-car filter, as shown in the next figure.

The advantage of the half-car analysis is that it more closely matches the way road meters are installed in passenger cars. There is a subtle difference in the way the vehicle responds.

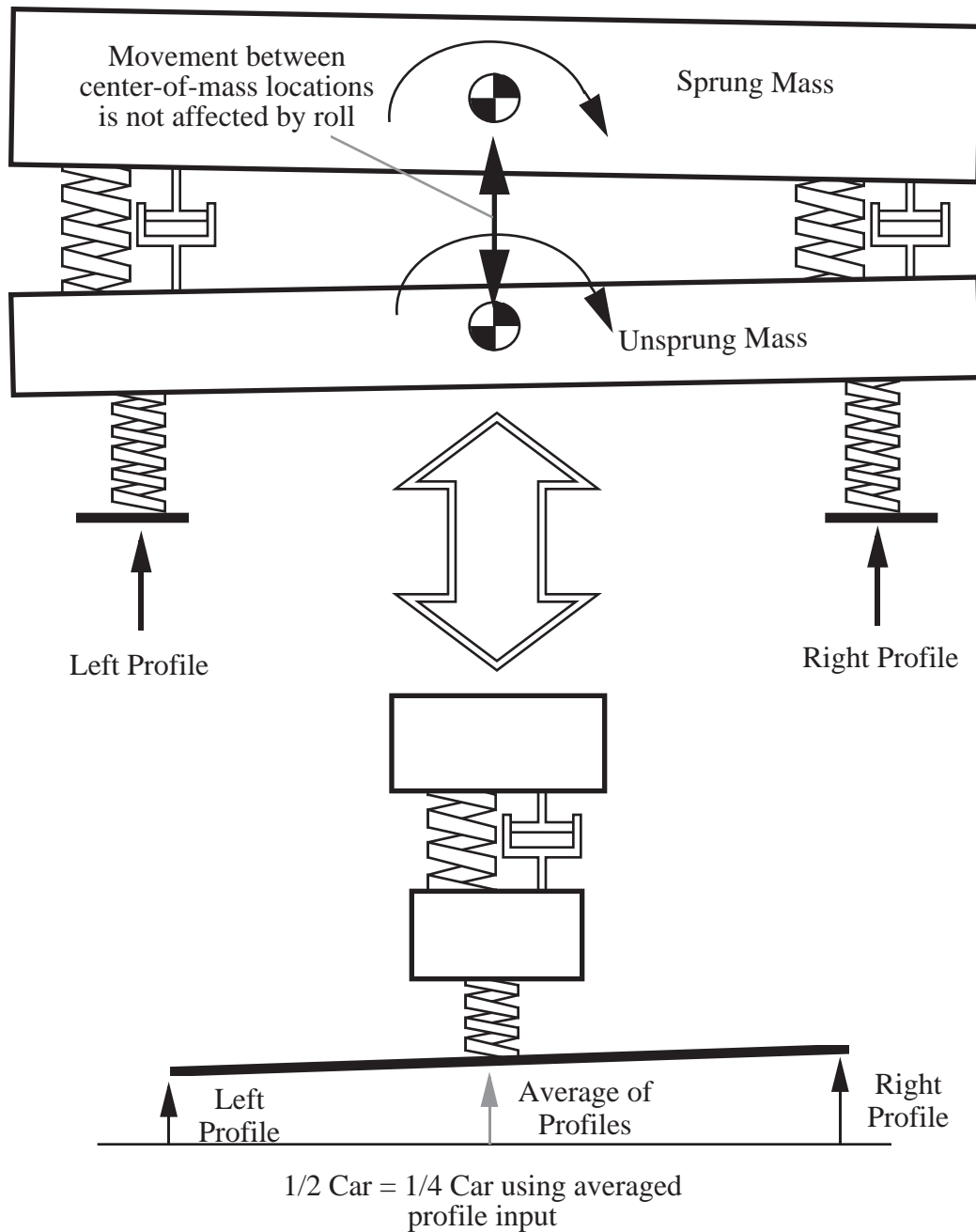

Consider a sinusoidal input. If both sides receive the same sinusoid, in phase, then the whole vehicle bounces in response. It does not roll at all. However, if they are out of phase, such that the left side goes up when the right side goes down, the vehicle rolls but doesn't bounce. With the road meter installed at the center of the axle, it senses bounce but not roll. In real roads, there is a mixture of bounce and roll. The bounce part gets through, but the roll part does not. Consequently, the roughness

as calculated with an HRI analysis must be less than or equal to the result obtained from the IRI analysis.

A disadvantage of the half-car analysis is that in order for it to work, the two profiles must be perfectly synchronized before they are averaged. For profilers that measure profiles in two wheel tracks simultaneously, the two are properly synchronized and this is not a problem. However, for profilers that profile only one line, it would be extremely difficult and time consuming to make two passes (measuring the profiles of the left and right wheeltrack) and then align the two profiles within a foot, as needed for the analysis. Practically speaking, the HRI analysis can only be used for systems that profile two wheel tracks simultaneously.

Profile data taken in some research projects in the 1980's were analyzed both ways. The HRI values, calculated from the average of the left and right profiles, were compared to the average IRI values calculated separately for the left and right profiles. The correlation between the HRI and averaged IRI statistics was very high, indicating that little or no additional information is provided by the HRI.

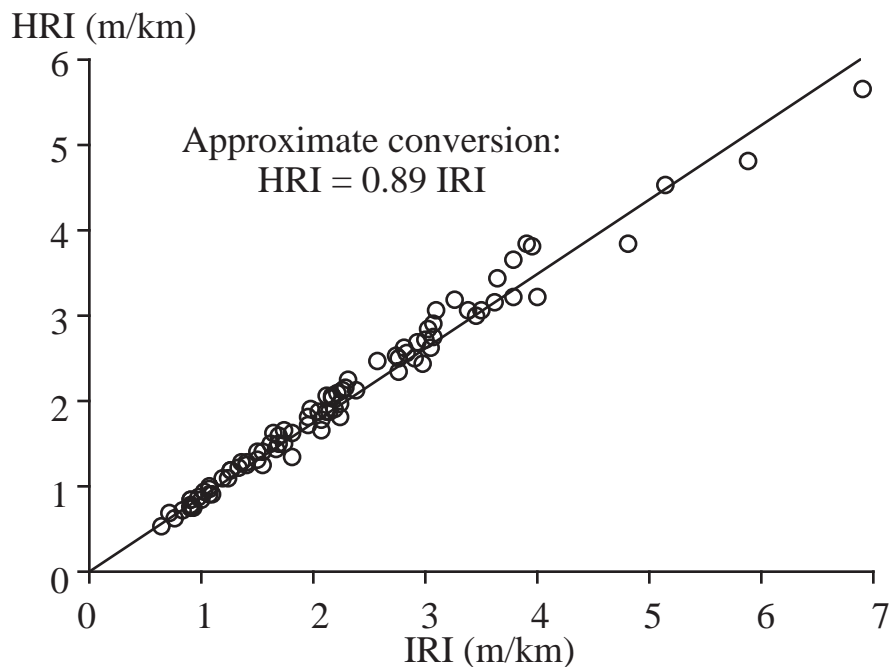

For more information about the differences between HRI and IRI, see the TRB paper:

Sayers, M.W. "Two Quarter-car Models for Defining Road Roughness: IRI and HRI." *Transportation Research Record 1215*, (1989) pp. 165-172.

☞ **Mays Response Meter (MRM) on some profilers is HRI with adjustable simulated vehicle speed.**

The research described in NCHRP Report 228 investigated the correlation and calibration of response-type systems, and described a standard quarter-car model called the Golden Car. K.J. Law, Inc. participated in the research, providing profile measurements upon which the analyses were tested. The model developed in the research was included with the software in Profilometers made by Law. The *Mays Ride Meter* (MRM) simulation was the name of the Law version of the half-car model. If set for a simulated speed of 80 km/hr (49.7 mi/hr), the MRM simulation is the same as the HRI analysis.

☞ **RMSA is an alternate output from a quarter-car model.**

Engineers concerned with vehicle performance generally characterize ride using data that is measured in a moving vehicle. Ride is most easily described using vertical acceleration, which can be measured with an accelerometer. The quarter-car model used for IRI and HRI calculations can also give simulated vertical acceleration as an output. As a profile-based statistic, the simulated vertical acceleration provides a time-stable measure of ride. The acceleration is summarized with a root-mean-square (RMS) value, leading to the acronym RMSA. The analysis was originally called RMSVA, but was changed to avoid confusion with an index by that name that was recommended by Prof. W.R. Hudson and is described next.

Statistically, the RMSA correlates almost perfectly with HRI and IRI if a standard simulation speed is used. Thus, it provides little additional information about the profile if IRI values are already being calculated.

☞ **RMSVA is nearly the same as a rolling straightedge.**

In the late 1970's W.R. Hudson and others tested several simple profile analyses for use in calibrating response-type systems and as profile-based summary roughness statistics. They proposed a simple filter to process the profile elevation, with the form:

$$A_i = \frac{Y_{i+2k} - 2Y_{i+k} + Y_i}{B^2}$$

where Y_i is the i^{th} profile elevation, k is an integer parameter for the filter, and B is the base length ($B = k \cdot \Delta X$).

Now consider a rolling straightedge, shown below. This device senses the deviation at the center of a straightedge that is supported at either end.

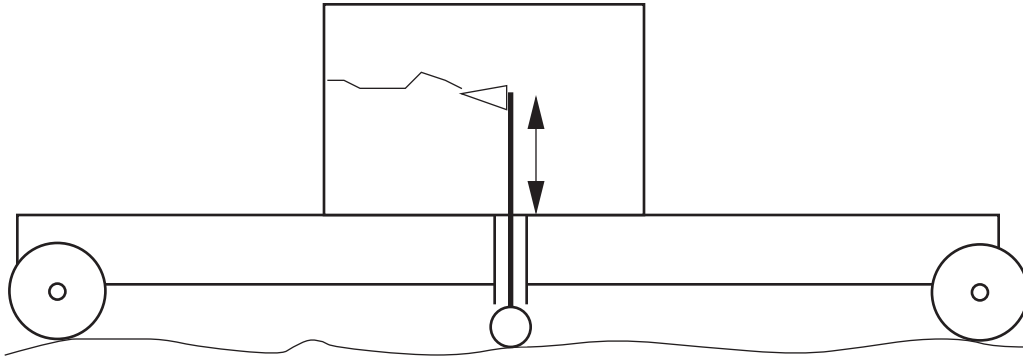

The equation for the output of a rolling straightedge is

$$SE_i = \frac{1}{2} (Y_i - 2 Y_{i+k} + Y_{i+2k})$$

This is shown geometrically below.

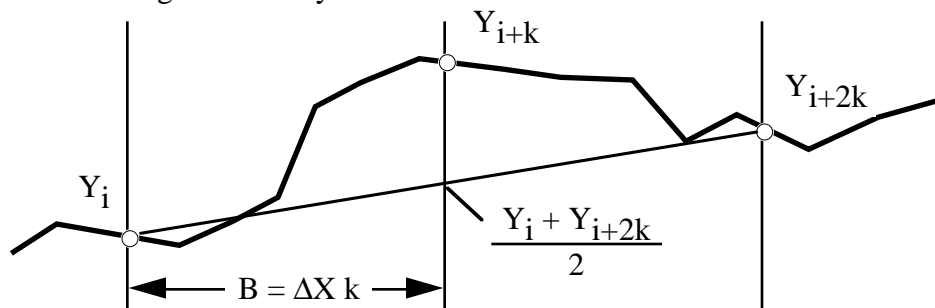

Thus, RMSVA is proportional to the output of a rolling straightedge whose full wheelbase is $2B$. There is also a scale factor between the two:

$$A = \frac{2 SE}{B^2}$$

Hudson and others proposed that RMSVA statistics for different base lengths be calculated and combined to provide a roughness index such as MO, described next.

Despite the name, RMSVA has little to do with vertical acceleration of the profile.

There are two technical problems with RMSVA. One is that it requires the sample interval to divide evenly into the base length of interest to obtain the integer k for the above equations. For example, if the base length is 4.0 ft, a sample interval of 1.14 ft results in $k=3.5$. Setting k to 3 or 4 changes the effective base length and gives different results. Strictly speaking, a profiling device is not valid for RMSVA analysis unless the sample interval is set to divide evenly into the specified base length. Thus, RMSVA is a profile index that is not transportable.

A second problem is that RMSVA values are slightly lower from inertial profilers than from static devices, due to anti-aliasing filters in the inertial systems.

☞ **Texas MO and Brazil QI are based on RMSVA.**

Hudson and others proposed an index for the same general purpose as the IRI. It was defined as:

$$MO = -20 + 23 \text{ RMSVA}_4 + 58 \text{ RMSVA}_{16}$$

where RMSVA values were calculated with base lengths of 4 and 16 ft. The symbol MO referred to a specific vehicle with a Mays Ride Meter. The equation predicted the output of that device over a period of a few years in the early 1980's. Being a transform of RMSVA, it has the same limits as RMSVA.

Cesar Queiroz and others from Brazil proposed a similar roughness index to calibrate response-type systems. QI stood for quarter-car index, and an equation was developed to predict the output of an early GMR profiler with an electronic quarter-car simulation:

$$QI = 8.54 + 6.17 \text{ RMSVA}_{1.0} + 19.38 \text{ RMSVA}_{2.5}$$

where the RMSVA values were computed with base lengths of 1.0 m and 2.5 m.

Research has shown that MO and QI correlate highly with IRI. If IRI is already being calculated, then there is no additional information provided by MO and QI.

Several Ride Number indices have been described in the literature.

As soon as the inertial profiler was developed by General Motors Research, it was tested and evaluated by the Michigan Department of Transportation. Psychological testing by Dr. Holbrook of the Michigan Department of Transportation (DOT) linked user opinion to wavelengths in roughness power spectral density (PSD) functions in the late 1960's. Based on Holbrook's work, John Darlington of the Michigan DOT developed an electronic filter to produce a profile-based statistic called Ride Quality Index (RQI). RQI has been revised several times since then, and details of its current implementation are not yet published.

As described earlier in the section on Ride Number, the National Cooperative Highway Research Program (NCHRP) sponsored two research projects by Dr. Michael Janoff in the 1980's that investigated the effect of road surface roughness on ride comfort, as described in NCHRP Reports 275 and 308. Simultaneously, the Ohio Department of Transportation (DOT) funded research by Elson Spangler and William Kelly of Surface Dynamics, Inc. on the same topic. As part of those research programs, mean panel ratings (MPR) were obtained for roads that were also profiled. Profile-based analyses were developed to predict MPR. Janoff described a method in which PSD functions were calculated for two longitudinal profiles and reduced to provide a summary statistic for each profile called PI (profile index). The PI values for the two profiles were then combined in a nonlinear transform to obtain ride number on a 0 to 5 scale. The mathematical transform is described in NCHRP Report 275, but not in complete detail. Software for computing RN with the PSD method has not been developed for general use.

Spangler and Kelly analyzed the same data set and developed an alternative profile analysis that was linked to MPR. It uses a high-pass filter, rather than PSD, to define a profile index for two wheeltrack profiles. The PI values are transformed to a 0 to 5

ride number scale. Later research showed the equation predicted mean panel ratings only for profiles obtained with a sample interval of 6 inches.

The Ride Number analysis described earlier was developed after the two existing RN analyses were investigated and applied to profiles obtained from a variety of instruments. All three of the RN analyses involve filtering profiles to obtain a summary index called PI, which is then transformed to a 0 to 5 scale. Because different transforms are used to get PI, the PI values are not compatible for the different versions. Also, different conversion equations are used to calculate RN from PI. However, the overall result is that the RN values from all three methods are nearly identical if the profiles were measured with the same type of profiler used in the NCHRP research.

At the time the little book was last edited (September 1996), none of the ride number analyses were in widespread use. However, free computer software to perform the ride number analysis described in an earlier section is now available through the Internet.

Present Serviceability Index (PSI).

As described in the discussion of Ride Number, Carey and Irick defined PSI and a measure of pavement performance for the AASHO Road Test. They used present serviceability ratings (by a panel of users) and statistical analyses to find a way of predicting the PSI of roads with a combination of objective measures of pavement condition, one of which was a roughness measure. They proposed:

$$\text{PSI} = 5.03 - 1.91 \log(1 + \overline{SV}) - 1.38 \overline{RD}^2 - 0.01 \sqrt{C + P}$$
 for flexible pavements
and

$$\text{PSI} = 5.41 - 1.78 \log(1 + \overline{SV}) - 0.09 \sqrt{C + P}$$
 for rigid pavements,

where \overline{SV} was the mean slope variance, \overline{RD} was the mean rut depth, and C and P were cracking and patching indices, respectively.

When Carey and Irick defined PSI, they also suggested its use as a standard performance indicator for road network monitoring. The concept is still in use today, but has not been standardized. A variety of methods and perhaps over one hundred formulas have been developed independently by State agencies and consultants for calculating a version of "Serviceability Index." Many of them were linked directly to the output of specific response-type systems. Several States currently calculate their own version of PSI that combines a profile roughness index with other measures of distress.

Some States with profilers calculate a version of PSI using regression equations involving profile indices such as IRI. Be aware that if a profile index is converted to PSI, it is still reflecting the sensitivity of the original index. No additional information is provided. The main practical reason for performing such a transformation is to deal with the requirements of existing pavement management software. If the software can

be updated to handle profile indices with different units, then conversion to a pseudo-PSI statistic should be abandoned.

Tests where the same roads were measured by different States have shown differences in PSI by over one PSI unit.

What Is the Effect of Length?

For network monitoring, it is sufficient to determine roughness levels on a per-mile basis (or some other manageable length). However, for diagnostic work and research, it is useful to be able to pinpoint exactly where a road is rough and where it is smooth.

 **Roughness indices can be computed for various lengths of profile.**

Consider the following table showing IRI values for two sections of road that are 152 m long. The IRI values are shown both for the entire sections, and also in 30-m sections. For example, the roughness for the left profile (LElev) of Site 1 is 2.70 m/km over its entire length. However, the five 30-m sections show IRI numbers as low as 1.35 (120-150) and as high as 5.66 (60-90).

Site	Start: m	End: m	IRI: LElev.	(m/km) RElev.
Site 1	.00	150.00	2.697	2.686
	.00	30.00	1.995	1.705
	30.00	60.00	1.762	1.922
	60.00	90.00	5.662	5.540
	90.00	120.00	2.762	2.938
	120.00	150.00	1.351	1.269
Site 4	.00	150.00	2.464	2.440
	.00	30.00	1.831	3.311
	30.00	60.00	3.303	3.023
	60.00	90.00	3.894	1.930
	90.00	120.00	1.492	1.426
	120.00	150.00	1.766	2.494

Now compare the two sites, looking at the right-hand profile (RElev). Site 1 has a total roughness of 2.69 m/km, and Site 4 has a comparable level of 2.44 m/km. However, the range of roughness values in 30-m sections is as high as 4.27 m/km in Site 1, but only as high as 1.88 m/km for site 4. Thus the roughness is more uniform for Site 4 than it is for Site 1.

 **Profile-based indices are affected by where a profile starts and stops.**

For example, the IRI analysis was rerun for Site 1, starting the 30-m intervals at 20 m instead of 0 m. The following table was obtained.

Site	Start: m	End: m	IRI: LElev.	(m/km) RElev.
Site 1	.00	150.00	2.697	2.686
	20.00	50.00	1.596	1.747
	50.00	80.00	3.782	3.426
	80.00	110.00	4.471	4.727
	110.00	140.00	1.853	1.861
	140.00	150.00	0.974	1.178

Look again at the values for the right-hand profile (RElev). The big difference is that the largest IRI value for the right-hand profile is now 4.73 m/km, instead of 5.54 m/km. The roughness around 80 m into the section is now spread over two adjacent 30-m sections, where its influence is diluted.

 **A roughness profile shows roughness vs. distance.**

A roughness profile adds another dimension to the description of road roughness. Rather than providing a single index that summarizes the roughness of a road section, it shows the details of how roughness varies with distance along a road section. It is generated for a fixed length L used for averaging. At a point in the profile, take the IRI for the interval starting at $-L/2$ prior to the current location, and ending $+L/2$ past the current location. For example, if the averaging length is 30 m, the IRI value for the first 30 m is plotted at $X=15$. The IRI covering the range of 1 to 31 is plotted at $X=16$. The next figure shows the roughness profiles for the same data used in the previous tables.

The figure includes all of the IRI values listed in the previous two tables for the right-hand profiles. For the first table, the values occur at $X=15, 45, 75$, etc. For the second, they occur at $X=35, 65, 95$, etc. Further, the figure shows the values for every possible table that could be made, using a 30-m print interval.

A quick glance at the roughness profile for Site 1 shows that the roughest 30-m section is centered near the point $X=80$ with a level over 6 m/km. (The maximum is actually 6.31 m/km, for the interval centered at $X=82.75$.)

 **Length affects the variation seen in roughness indices.**

For very long sections, the effects of rough sections are averaged out. If you summarize IRI over long intervals, such as a mile, you might not see the that one very short section is significantly rougher than anything else for miles.

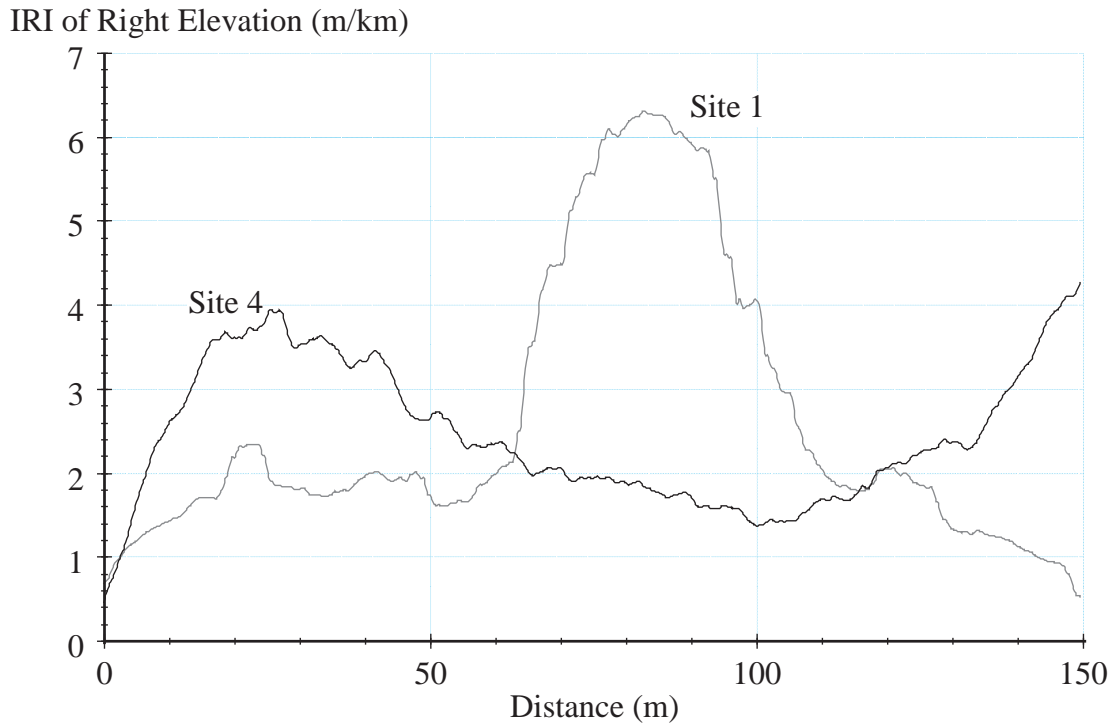

Roughness profile based on 30-m length.

The range of IRI values obtained depends on the lengths used. This might seem surprising at first, because, like most profile indices, IRI is normalized by length. Length does not affect the average—it affects ranges of IRI that are seen above and below the average. The effect of length is shown in the next figure, based on the same data used for the previous figure and tables. In this case, the IRI is computed for the relatively short distance of 10 m. Notice that for Site 1, the IRI values range from a low of 0.75 m/km at X=22 m, to a high of 11.08 m/km at X=83 m.

☞ Roughness profiles require linear accumulation.

A characteristic of the IRI is that the average of the IRI values of two adjacent sections of road are the same as the IRI for the total. This is not true of PSD functions or Ride Number, because the outputs are not linearly accumulated.

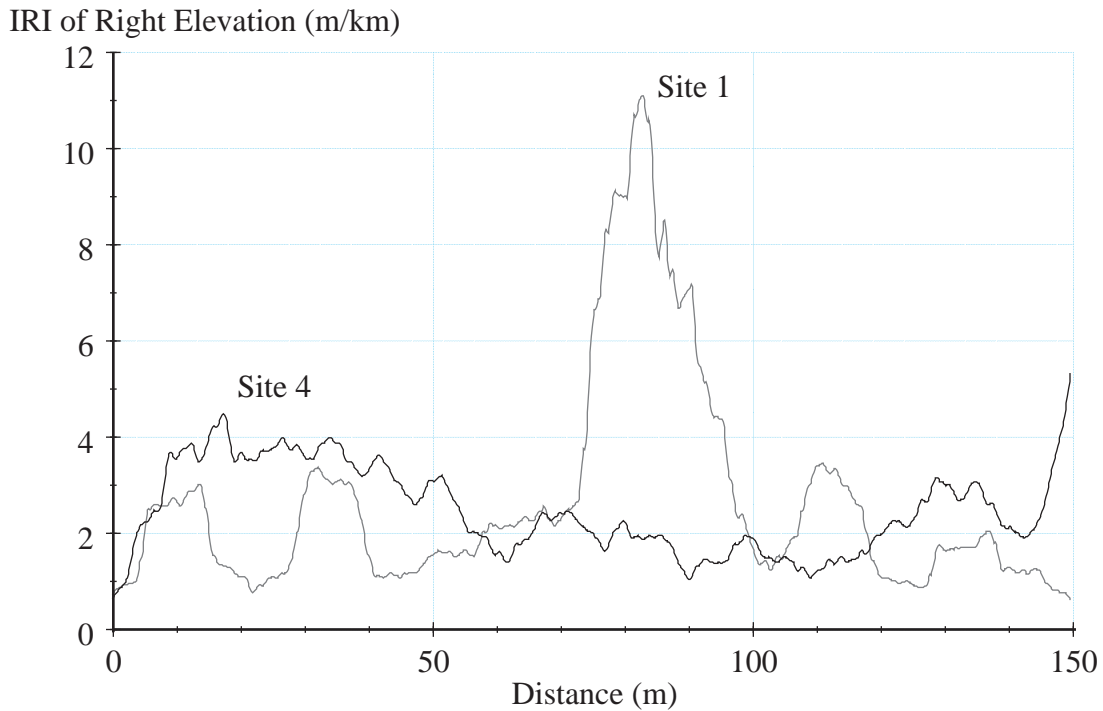

Roughness profiles based on 10-m length.

What Is Verification Testing?

Up to this point, we have covered what you can do with profile measurements that are **valid**. The assumption is that statistics such as IRI, RN, and PSDs taken from actual profile measurements are the same as would be obtained by analyzing the true profile.

How do you know your profile measurements are to be trusted?

Verification testing is used to confirm that a piece of equipment is operating properly. In general, verification testing will not determine if the equipment was properly calibrated or properly designed. Calibration and validation tests are more difficult to conduct and interpret, and are normally done by researchers and developers.

☞ **Before placing a new profiler in service, verify that its output seems reasonable.**

On one hand, a profiler is providing large amounts of information that are difficult to obtain any other way. But on the other hand, roughness indices such as IRI and RN are strongly linked to the public's perception of road quality. As a member of the public, you can evaluate whether numbers coming out of the computer make sense. Tests of this sort are sometimes called **reality checks** or **sanity checks**.

These simple tests cannot determine the accuracy of the system, but they can verify that it is producing output that looks reasonable.

For example, nearly all profilers include software to computer IRI. IRI values for highways typically range from 0.7 m/km for a very smooth new pavement, to 1.6-2.0 m/km for average sections, to 3 m/km and higher for sections that should be considered for repair. Highways rarely get to roughness levels higher than 3.5 m/km. Most heavily-traveled roads are in the range of 1.5-2.5 m/km.

 **Choose outputs that you use and understand.**

If you are using the profiler mainly to collect IRI values, verify its operation by getting IRI values. If you are using it to view profiles, verify its operation by inspecting plots of profiles.

 **Determine the repeatability.**

In practice, no profiling device is perfect. Errors exist. If you profile the same imaginary line in the road several times, you will not get exactly the same result each time. (There will be more discussion on this later.) However, you should get almost the same result with repeated measurements.

The repeatability is usually better for longer profiles. If you are processing the profiles to get IRI, you should be able to repeat the measured values within 5% for profiles that are one mile in length. With care, you should be able to repeat within 1 or 2%. For shorter profiles, larger variations occur.

 **If the output is not reasonable, call the factory!**

If you obtain questionable outputs from the profiler, it probably wouldn't hurt to read the instructions that came with the system and check that everything is connected properly.

If you suspect the device is not valid, that it is not giving the same results as you would obtain for the true profile, then there is little you can do to compensate. Something in the system is not working right and it has to be fixed.

 **Periodically verify that the measures from the profiler remain reasonable.**

A profiler has many parts that can fail and place the accuracy of the measures in jeopardy. Like any complex measuring system, your profiler should be tested periodically to ensure it is working as intended. You should establish periodic "sanity checks" to verify that the system appears to be working.

A good practice is to establish highway sections that can be used as verification sites. Profile them on a regular basis and compare the new readings with those obtained in the past. Try to include a site that is fairly smooth and one that is rough.

The readings from these sites are **not** used to adjust future outputs. The instrument is either a valid profiler, or it is not. If it is not, get it fixed or stop using it.

What Is Calibration?

Much of engineering measurement involves conversion between different physical variables (voltage, inches, etc.) and conversion between different units scales applied to the same type of measure (inches, meters, etc.)

☞ **Calibration is a process of correcting the scale of a measuring device.**

For instruments that measure steady-state properties, calibration involves determining a scale factor by comparing the output of the instrument to a known input. For example, the calibration of laser height sensor in a profiler might be checked by setting the distance between the laser and its target to a known value and then reading the output of the sensor. If the reading is in error, then an electronic adjustment is made to calibrate the sensor. The test would usually be performed for several different distances to ensure that the output of the sensor is linearly proportional to height above the ground.

☞ **Calibration of a profiler is done in the laboratory.**

A typical inertial profiler includes an accelerometer, a non-contacting height sensor, a longitudinal distance sensor, a computer, and assorted electronics to power the sensors and connect them to the computer. Each sensor is independently calibrated. If any single part does not work properly, then the profiler as a whole cannot provide valid profiles.

Depending on the design of the system, it may not be possible for you to calibrate the individual components. Special equipment is usually needed. In most systems of similar complexity, the sensors are calibrated at the factory, and remain in calibration throughout their life.

The manufacturer may require that you perform periodic calibrations of some parts of the system. For example, the distance measuring instrumentation may be adjustable without advanced equipment. However, if the manufacturer does not provide instructions for calibrating parts of the system, they are probably not intended to be adjusted by you.

☞ **You cannot calibrate a profiler by measuring roughness.**

Given that you calibrate a height sensor by giving it a known height input and reading the output, you might suppose that a profiler should be calibrated by measuring a profile with a known roughness level (e.g., IRI). This is wrong.

The exact conditions that contribute to the roughness index of a true profile are usually unique for that profile. The contributions of various wavelengths are generally different for another true profile even if it has the same summary index value.

When you check the value of a roughness statistic computed from your profiler by comparing it to a reference, this is a **verification test**, which is described

earlier. If the agreement is not satisfactory, then the profiler is not valid for that condition. It is then time to call the manufacturer!

☞ You do not calibrate equations or computers.

Remember: half of the measuring process involves the analysis made of the profile data. The analysis part of the process is fixed in the computer software. The equations are either programmed correctly the first time, or they are not. The analysis part of the process is not something that can change with time and use, and it is not a part of calibration.

What Is Correlation?

Correlation is a mutual relation or connection between different variables. Statistically, it is the degree of correspondence between two data sets.

☞ Correlation analysis describes how much of the variation in variable Y is related to variation in variable X.

Consider the data shown in the next figure. There are two sets of data, each representing roughness statistics taken from the same profiles. Values of one statistic (PI #2) are plotted on the Y axis against values of IRI, plotted on the X axis.

The figure shows that, in general, increases in values of IRI are linked with increasing values of PI #2. However, the relationship is not perfect. Both IRI and PI #2 are the outputs of mathematical transforms that respond differently to sinusoids according to their wavelengths. Two specific profiles might be ranked differently by IRI and PI #2.

☞ A correlation coefficient describes the relation between two variables.

The regression analysis fits a function to predict Y as a function of X. The function, $f(X)$, is usually a linear equation with an offset and gain. The constants in the equation are calculated in the analysis to minimize the squared differences between the Y values and the “fitted” values $f(X)$. The regression equation is shown in the figure, along with a squared correlation coefficient:

$$R^2 = \frac{\text{variance of } f(X)}{\text{variance of } Y}$$

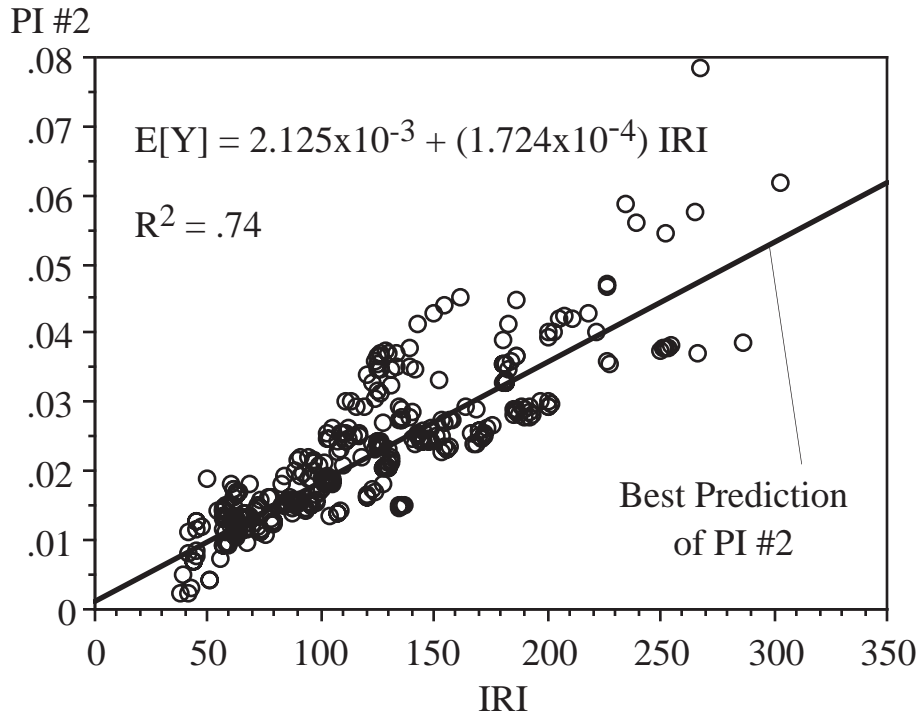

The R^2 value is normalized to stay in the range between 0 and 1. If the fitted equation predicts Y perfectly, then all of the data points in the figure would lie on the regression line, and R^2 would equal 1. If R^2 is zero, it means that the assumed form of the equation cannot use the values of X to improve the estimate of Y . Regardless of the value of X , the best estimate of Y is its mean value.

☞ **R^2 depends on the range of data.**

The two plots in the next figure involve points taken from a larger data set with well-defined statistical properties. Y is equal to X , plus a random error with a standard deviation of 10. In the first plot, the values cover a large range, and a high R^2 is obtained. In the second, the values cover a limited range. The random error is more significant relative to the range of the data, and a lower R^2 value is obtained.

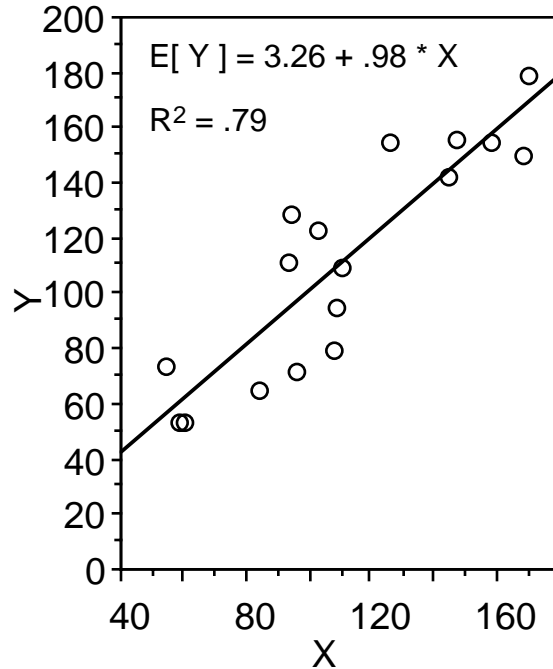
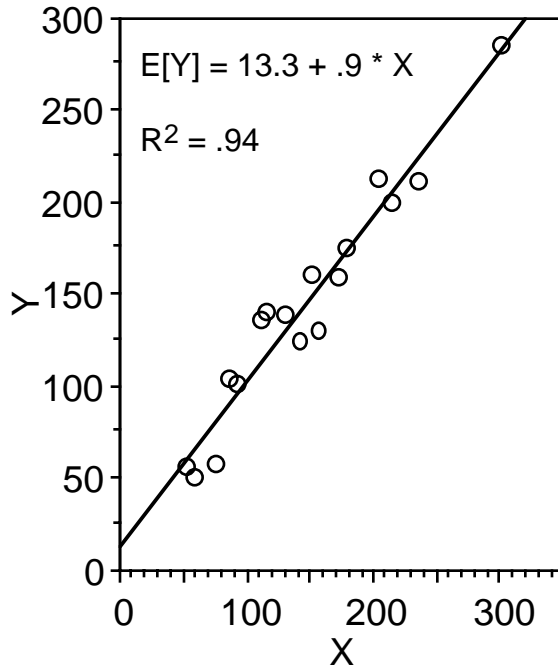

☞ **R^2 depends on the form of the model.**

The two plots in the next figure involve the correlation between mean panel rating and a profile index. The MPR scale goes from zero to five, whereas the profile index is linear with profile amplitude. The relationship between the two turns out to be highly nonlinear. A direct comparison (part a of the figure) shows an R^2 of 0.51, with a lot of scatter because the assumed straight-line fit does not match the data. But when the index is transformed with an exponential equation into a zero-to-five scale (part b of the figure), the straight line is a better approximation, and a higher R^2 applies.

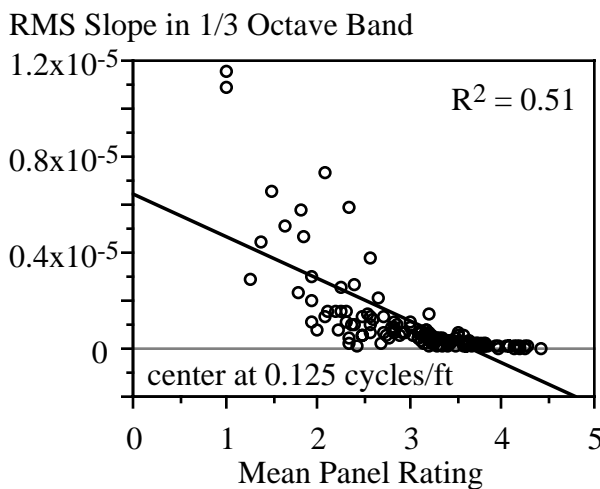

(a) linear fit

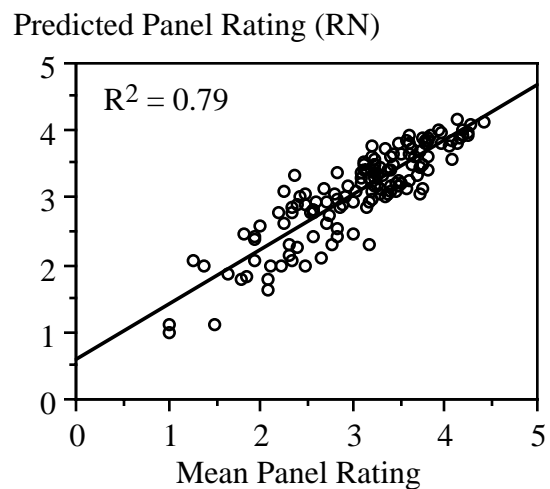

(b) exponential fit

Effect of nonlinearity on R^2 .

☞ **Correlation analysis is used to quantify measurement error.**

For example, measures made with a profiler might be compared with measures from a more accurate profiling system thought to capable of measuring the true profile with negligible error. Consider two data sets, each with IRI values calculated from different profilers. Values from the two data sets are plotted against each other in the next figure.

In the definitions that follow, $E[\]$ is the expected value of what's in brackets $[\]$. In other words $E[x]$ is the mean value of x .

☞ **RMS error indicates the expected error in a single profiler measure.**

$$\text{Root-mean-square (RMS) error} = \{E[(\text{measure} - \text{truth})^2]\}^{1/2}$$

All profilers exhibit some total RMS error level. For closely scrutinizing a few specific road sites, such as newly repaired or constructed pavement, the RMS error should be low. For routine monitoring of a road network, a higher RMS error level can be tolerated.

Without taking special efforts to locate the imaginary profile line precisely, RMS errors under 5% can be expected for profiles that are about a mile long, assuming the profiler is highly accurate. Experience in past research programs indicates the errors in IRI roughness can be controlled to several percent for test sections that are 0.1 mile long (528 ft), if special care is taken by the operators to profile the same line that was used to obtain a reference profile.

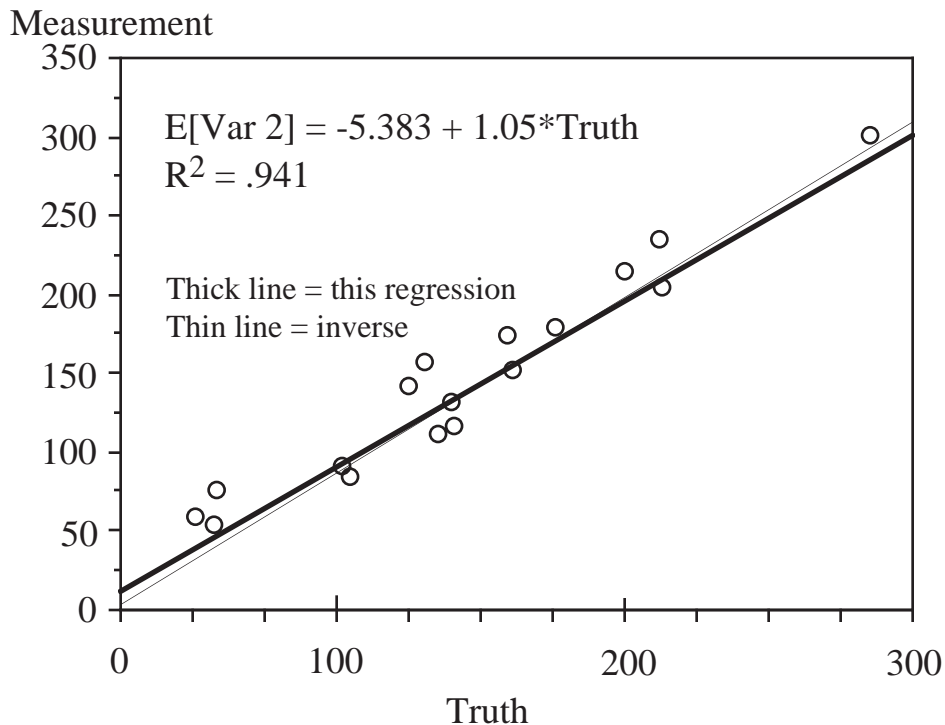

☞ The average of the errors from many measures is the bias error.

$$\text{Bias} = E[\text{measure} - \text{truth}]$$

The bias error indicates whether a profiler is systematically high or low compared to the truth. The bias error for a valid profiler should be very small. Bias levels of 1% and less can be expected for profilers that are valid for the index being used.

If the profile data are being used for PMS applications, bias is potentially a serious problem. Bias errors distort the aggregate picture of the state of a network, indicating that things overall are better or worse than they are. Significant bias errors prevent meaningful comparison to measures from valid profilers.

☞ Significant bias error means the profiler is not valid.

This statement may not be welcome news, but that's the way it is.

Bias error is caused by an error in the factory calibration, physical damage to the system, or a defect in the profiler design. Bias can exist for some profile statistics but not others, because the factors causing bias may or may not apply for a specific profile analysis.

☞ Standard error is a helpful indicator for developers and researchers.

$$\text{Standard Error} = \{E[(\text{measure} - \text{truth} - \text{bias})^2]\}^{1/2}$$

Standard error is the portion of the total error due to random effects. It is good for researchers and developers of profiler technology to understand the sources of errors in their instruments. For end-users, the total RMS error is the more meaningful measure. If the bias error is negligible, as it should be for a valid profiler, then the standard error equals the RMS error.

☞ Correlation analysis is used to calibrate response-type instruments.

Users of response-type systems must calibrate them to a reference that is reproducible and stable with time. This means that the reference must be a statistic defined for true profile. Usually, values of IRI calculated from measured profile are used.

For this application, a set of test sites is established. IRI values are determined by analyzing profiles taken for the sites. The instrument to be calibrated is driven over the sites, and a regression analysis is performed. Results for one such instrument are shown in the next figure.

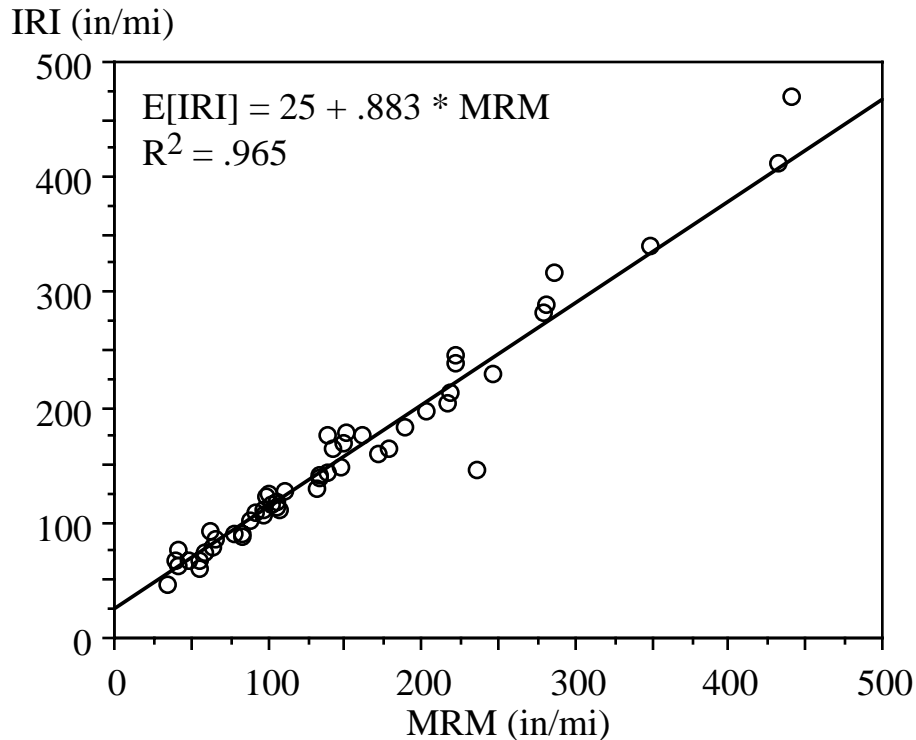

The regression equation is developed with the “truth” on the Y axis, and the instrument being calibrated on the X axis. The regression line is used as a calibration curve, to convert measures on the arbitrary scale of the instrument to estimates of the profile-based reference (e.g., IRI).

This method of converting raw measures from the instrument to a standard scale is called *calibration by correlation*. It is necessary because a response-type instrument cannot be calibrated any other way. The measuring system depends on the dynamic response properties of the vehicle in which the road meter is installed. The overall properties are complex, depend on many factors outside the users control, and cannot all be adjusted. Although the road meter is calibrated by conventional means at the factory, the response of the vehicle is unknown.

☞ Do not use calibration by correlation for profilers!

Calibration by correlation is time consuming and limited in accuracy. The desire to avoid calibration by correlation for response-type system is an important reason that States have been switching from response-type systems to profilers. If you use a correlation equation to convert outputs of your profiler system to match another profiler reference, then you are reducing the profiler to a response-type system.

Calibration by correlation is not needed for profilers because the dynamics of the host vehicle are not a factor when it is functioning as designed. Vehicle motions are eliminated from the profile produced by a valid, working system. The instrumentation and electronics are calibrated separately, using accurate laboratory rigs and special test equipment at the factory.

If the outputs of your instrument do not agree with a profile-based reference, it's time to call the factory!

What Are Errors?

In a perfect world, you could make repeat passes down the same imaginary line on a road and obtain exactly the same profile statistics each time. Further, the results would match those obtained with other profilers. In fact, the agreement is not perfect.

 **Accuracy is a lack of error.**

Optimistic engineers speak of the accuracy of their systems. However, the accuracy is defined by the error. The smaller the error, the better the accuracy.

There are different concepts of exactly what an error is. Lets start with the view that a difference between two profiler measures indicate that things are not as good as they could be.

 **Repeatability is the ability to obtain repeat measures with the same instrument at (nearly) the same time.**

Suppose you take a profiler and make repeated measures along a line, over and over, until you have taken 10 repeats. Repeatability is defined by the variation of the profile indices taken for each run.

It is common to characterize the variation in a summary index such as IRI by taking the standard deviation of the measurements. The units of the standard deviation match those of the index. For example, if you process the profiles to obtain IRI with units of in/mi, the repeatability will be in terms of in/mi.

To scale the variation as a percentage, divide the standard deviation by the mean value of the measures, and multiply by 100.

To characterize the repeatability of your instrument, you should run repeat tests for different road conditions of interest. As noted earlier, textured surfaces are likely to cause measurement errors and should be tested. Rough sections generally show larger standard deviations than smooth sections. The next figure shows repeat measurements taken by a variety of profilers on the same road section.

For static profilers such as the Dipstick, repeatability is usually very good if the profiles are taken within an hour of each other. Larger repeatability errors are seen with inertial profilers operated at highway speeds.

 **Repeatability is mainly of concern for diagnostic applications.**

Repeatability does not affect the mean value obtained with a profiler. Some calculated index values are too high and others are too low, but they average out.

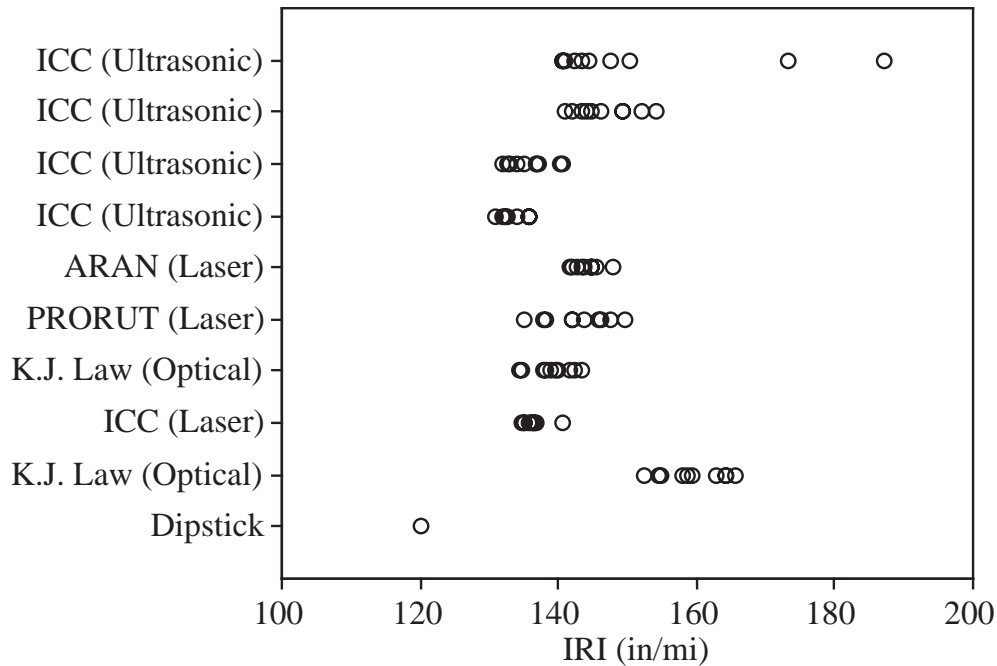

If a profiler is used to survey the condition of a network for statistical analysis, the repeatability will probably not be of great concern.

On the other hand, if the profiler is used to evaluate newly built or repaired roads, to reward or penalize contractors, repeatability assumes greater importance.

Reproducibility is the ability to repeat the measures with a different profiler of the same basic design.

Now suppose someone else takes a profiler similar to yours and makes repeated measures along the same line that you measured, and processes the profiles to obtain the same index (e.g., IRI). The difference in the average values obtained for the different instruments is the reproducibility. For example, the previous figure shows independent measures made with several profilers from the same manufacturer. There are four ICC ultrasonic units and two K.J. Law units.

To characterize the reproducibility of an instrument, it is necessary to make measures on a set of test sites, taking repeat measures with both instruments on each site. The number of repeats that should be taken depends on the repeatability of the instruments and the testing methodology. If they are very repeatable, a single measure might be sufficient. For less repeatable measures, sufficient repeats should be taken to obtain a mean value of the profile index with some confidence.

For profilers, reproducibility is not of as much interest as portability.

Portability is the ability to repeat the measures with completely different profiler designs.

The standard for portability is the true profile. Recall that a profiler is considered valid if values of a given index are neither higher nor lower, on average, than values

of the index obtained from true profile. Because any valid profiler is linked to the true profile, its measures are portable by definition.

On the other hand, if the measures are not portable, then the profile is not valid. Simple.

The previous figure shows the degree of portability that existed for measuring IRI for a particular PCC test section. The reproducibility between similar profilers was about the same as the portability between devices from different manufacturers.

The true profile is more of a concept than a reality. Given two profilers, which one gives the truth? The accepted method for establishing that a profiler is valid for measuring an index to test it against a static method such as rod and level or a Dipstick. For IRI or analyses that can be applied for profiles taken with a 1-ft sample interval, the Dipstick is a popular choice.

 **Repeatability and reproducibility can be calculated for each point in a profile.**

If you are using profile plots to diagnose pavement condition, then you may want to compare the profile plots for repeat runs. One method, described in ASTM standard E950, is to apply an identical high-pass filter to each profile, treat the elevation values of each point along the profile as an independent measurement. The standard deviation at each point can be calculated.

The interpretation of the variability of each point is not clear. As shown in previous sections, analyses have sensitivity that changes with wavelength. Also, the amplitudes associated with PSD functions show that elevation amplitudes are mainly a function of how the profile is filtered to remove long wavelengths.

More research needs to be done to evaluate the usefulness of point-to-point repeatability and reproducibility. The point-to-point variability does not have a direct link to error in specific profile indices such as IRI and Ride Number.

What Causes Profiling Error?

The act of profiling involves: (1) a user, (2) a profiler, and (3) a road.

Errors are caused by: (1) the user, (2) the profiler, and (3) the road.

 **You are profiling a different line each time.**

A major source of variation in profiler measures is that a different line on the road is being profiled each time, and the lines simply have different true profiles. For static profilers, the line is usually marked physically, and this error is small. For inertial profilers, variations in choosing the line on the road are usually more significant than any other errors.

Assuming that you drive the profiler along a path parallel with the centerline of the road, there are two variables that locate the line being profiled:

1. the longitudinal starting position, and
2. the lateral position.

At 100 km/hr, you cover almost 28 meters each second. The normal human reaction time of several tenths of a second corresponds to distances of 5 to 8 meters. In addition, when you trigger the profiler to start sampling, there may be a delay that depends on the design of the electronics and the computer software that controls the system during testing. The profile starts wherever the accelerometer and height sensors are located when the measurement process begins.

 **Even expert drivers add variability to starting locations.**

In past research programs, where test sites are marked with paint on the road, and profilers have been run by experienced teams with a driver and instrument operator, errors of 60 meters have been observed. Even the best teams had starting errors of 10 meters or so.

The roughness profiles shown earlier reduce the sensitivity of where the profile is started, because they show roughness information for all possible starting locations.

The line being profiled is located directly under the height sensor. In most profilers, it is in line with the wheels of the vehicle. However, the driver of the vehicle should vary its location.

 **Lateral position is also important.**

Highly skilled drivers can maintain a lateral position within about 15 cm. However, variations of 30 to 50 cm are more common.

Operating some of today's profiling equipment is so easy, that the driver can forget about the data being collected and drive like a normal motorist, even changing lanes. A profile exists for a line that crosses from one lane to another, but it is not something that can be easily reproduced.

 **The profiler has measurement error.**

The valid measurement of profile requires that all parts of the system function correctly: the accelerometer, the height sensor, the speed sensor, the power supplies, the electronic signal conditioning, the analog-to-digital converter, and the computer. Each part of the process involves some error. Ideally, the errors are small, but they do exist.

In past research programs, the main observed error sources for systems with laser and optical height sensors have been due to user practice. However, unexplained differences exist even in controlled experiments, as will be seen later.

 **The sample interval may be too large for the analysis.**

Most of the mathematical analyses applied to profile measures are nearly exact for very small sample intervals, but become approximate as the sample interval grows. As a user, you trade off the convenience of a larger sample interval with the potentially larger errors in the statistics calculated from the data. The next figure shows the error level in PI (the intermediate statistic used to calculate RN) as a function of sample interval. This shows that for sample intervals larger than 1 ft, even a perfectly accurate profile is not sufficient to calculate RN.

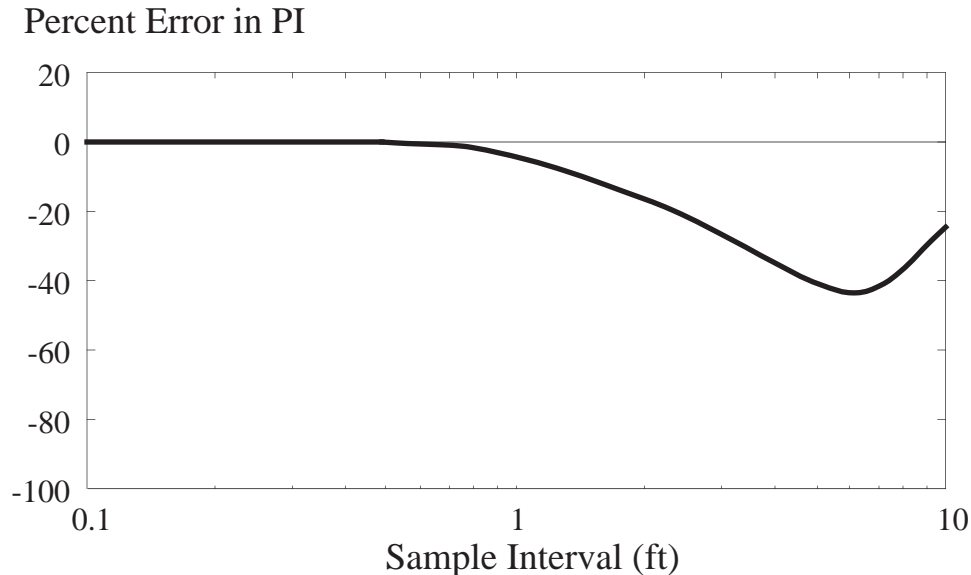

There is an effect called **aliasing** that can be a problem on textured surfaces. It involves an interaction between the choice of sample interval, the roughness characteristics of the road, and the analysis being applied. (Aliasing will be illustrated later in a discussion on texture.) This source of error is reduced with anti-aliasing filters in the profiler. However, not all profilers have anti-aliasing. For those that do not, the error is reduced by using a smaller sample interval.

Recall that ultrasonic sensors cannot provide rapidly repeated measurements because they must wait for echoing of the sound impulse to clear. At highway speeds, the required time limits the sample interval to about 1 foot.

Ultrasonic systems have more error.

Systems with ultrasonic sensors are not as accurate as lasers and other optical units. The ultrasonic sensor has a resolution of about 2.5 mm. A sinusoid with an amplitude of 1 mm (2 mm from peak to peak) and wavelength of 3 meters has an IRI value of 1.91 m/km. It would seem from this example that an ultrasonic sensor could not even begin to work! However, they do work, under limited conditions, because real roads are not sinusoids. If the vehicle motions are relatively large compared to the resolution of the sensor, the error is less significant.

Except in a few odd situations, the error due to limited resolution causes the roughness measured by an ultrasonic profiler to be higher than the true value.

For smooth roads, the limited resolution of the ultrasonic device assumes greater significance. Differences in performance have been observed with ultrasonic profilers from different manufacturers. The roughness level where the systems are valid depends on many factors and we do not have a rule of thumb.

 **A transducer may be disconnected or broken.**

When a profiler malfunctions, it is often because one part has failed completely. One cause is a broken connection.

Due to the complexity of the measuring process in an inertial profiler, it may still appear to be producing profiles even if a critical element is broken. Recall that the accelerometer and height signal together provide the information to generate the profile. They also provide the information to cancel the effect of the vehicle bouncing. If one of the sensors is broken or disconnected, you lose the profile contribution from that sensor, which tends to reduce the calculated roughness. However, you gain the vehicle bouncing that should have been canceled, an effect that tends to add to the calculated roughness.

Although you might think the vehicle motion is random, it actually repeats fairly well if you make repeat runs over the same road. Therefore, repeatability may still be good (although not as good as when everything is working).

With experience, you can tell if either the accelerometer or height sensor is missing by looking at plots of profile. If the accelerometer part is missing, the variation in the profile with no filtering will be much more limited than is normal, with a range of just an inch or so. For example, the following figure compares a profile measurement to the one obtained using only the height sensor output.

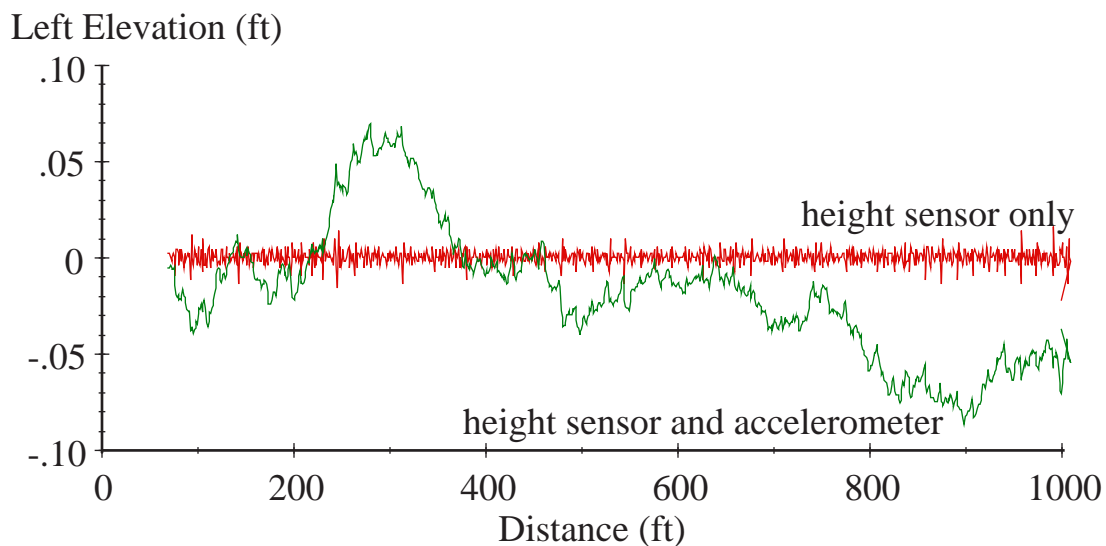

The IRI computed from the height sensor signal alone is about 97 in/mi, whereas the IRI computed from the actual profile is about 140 in/mi. Although these values are very different, the IRI value from the height sensor signal is in the expected range,

and might not cause any notice when entered into a data base. Without a profile plot, this error could go undetected.

If the height sensor is not working, the profile will be much smoother, showing no texture or sharp variations.

 **The height sensor might not work for the surface type.**

As mentioned earlier in the section on texture, textured surfaces are difficult to sense with ultrasonic height transducers, and can cause problems with some laser sensors.

Heavily cracked surfaces can also cause problems with laser sensors, as will be described in a later section on cracks.

 **The height sensor might not work for other reasons.**

Of all of parts that make up an inertial profiler, it is the height sensor that is most likely to fail in difficult conditions.

Laser and optical sensors should be checked to ensure that the lenses are clear, and not covered with dirt, rain, or mud that would prevent the continuous viewing of the image projected on the ground.

Ultrasonic sensors can also be affected by mud, dirt, etc. Without proper barriers, they are influenced by factors that change the time needed for sound to be reflected from the ground back to the vehicle. Wind changes the air pressure and the speed of sound. Outside noises can confuse the sensor logic.

The popularity of inertial profilers increased rapidly with the introduction of the South Dakota design, which employed low-cost ultrasonic sensors at a small fraction of the cost of laser-based devices. Unfortunately, performance is limited by the ultrasonic sensor. Some States (including South Dakota) have modified their systems, replacing the ultrasonic units with lasers.

The long-term solution is to replace the ultrasonic sensors with more accurate devices when the budget permits.

 **Speed can be a factor.**

The speed of measurement is integral to the proper operation of an inertial profiler, and will be discussed in the next section.

 **The true profile may have changed.**

The true profile can change with time. In particular, slab PCC pavements change daily in response to heating and cooling. When the top of the slab has shrunk, “slab curl” exists. Changes in IRI roughness of 20% have been observed due to this effect.

Besides the daily changes, seasonal changes can affect profile, as the ground moisture varies. Freezing and thawing seasonal changes also can have a big effect. For example, the plots below were obtained by Novak and DeFrain of the Michigan DOT, showing how the profile changes for an overlay pavement in Michigan.

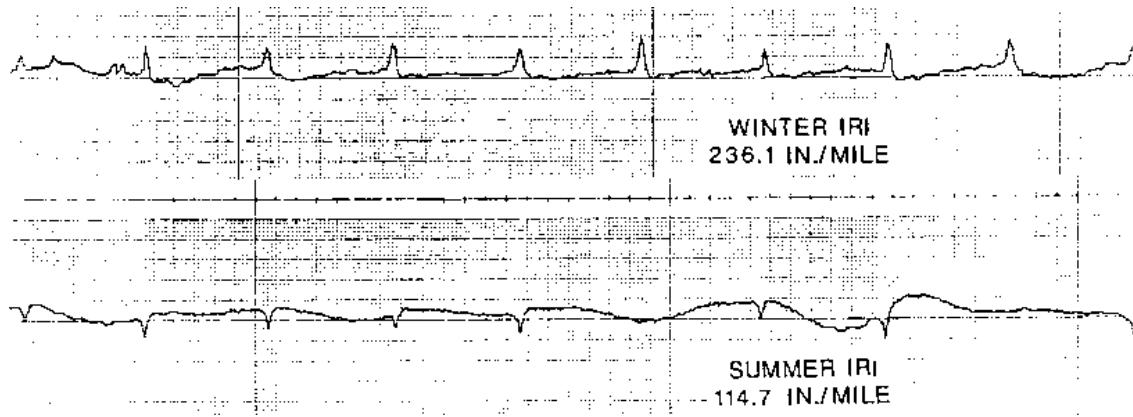

Variations seen in profile measurement due to changes in the true profile are of course not errors. The profiler is just capturing the current profile. Unfortunately, it is not always easy to determine if observed changes are in the true profile or in the measurement process.

What Is The Effect of Speed?

An inertial profiler is built on an ordinary highway vehicle, such as a van or passenger car. When it is not measuring profile, the vehicle can be driven at the same speeds that would be used if the vehicle did not have the instrumentation on board. But when measuring profile, what is the effect of speed?

☞ **Most profilers are valid for a range of speeds.**

Nearly all inertial profilers now in use produce profiles that are valid even if the speed changes during the measurement. The range of speeds depends on the profiler design and the use to be made of the data.

☞ **True profile is static.**

Remember that the true profile is a property of a line on the ground. It has no associated speed. If your profiler is valid for a given purpose, then its speed during measurement is not a factor.

Under no conditions should you consider a “speed correction factor.” If different results are obtained from your system at different speeds, something is wrong that must be repaired.

☞ **You will finish sooner if you go fast.**

Drivers of inertial profilers tend to figure this out fairly quickly.

☞ **It is harder to track an exact line at high speed.**

In applications where the intent is to capture a specific true profile, defined by a specific (imaginary) line on the road, low speeds make it easier for the driver to precisely locate the vehicle to follow the line.

A significant source of variability in repeated measures is variation in the lateral position of the profiler between runs. In one run, the profile line might go over a pothole, increasing the profile roughness. In the next run, if the operator goes just 8 inches to the right, the pothole is missed and a lower roughness is seen. Both results might be correct, in the sense that the instrument obtained a valid profile in each case. It's just that the profiles are based on different lines.

In the long run, variations like this average out. Potholes and other causes of roughness are scattered about the road. Roughness features omitted in one profile are made up for with additional features not present in other profiles on the same road. Unless close agreement for repeat measures is needed, the exact location of the line being profiled is not of interest, and the variability normal at highway speeds (60 mi/h) is acceptable.

The profiler senses longer wavelengths at higher speeds.

Recall that the inertial profiler has an accelerometer to sense vertical movement of the vehicle and establish an inertial reference. Ideally, the output of the accelerometer would be valid no matter how little the vehicle moves. However, in the real world of imperfect sensors and electronics, there is also electronic “noise.” The profiler works acceptably if the “signal” (output due to acceleration) from the accelerometer is significantly larger than the noise. However, if the signal is at the same level as the noise, or smaller, then the computer generates a profile that is in error because it is based on the noise.

The accelerometer and its electronics must be set to handle the largest vertical accelerations that are anticipated in normal use. A 1.0 g ($g = \text{gravity}$) vertical acceleration is the level where objects in the vehicle bounce in the air. The exact limit in a profiler depends on the design and possibly user settings, but it will be in the range of 0.4 g to 1.5 g. (For accelerometers mounted on the bumper or in utility vehicle, ranges may go up to 2 or 3 g 's.) With these settings, noise and other errors start to assume significance for acceleration levels less than 0.01 g.

Consider the three example sinusoids introduced earlier. The vertical acceleration that each causes as you drive over it (ignoring vehicle dynamics) depends on speed. The table below shows the relation between speed and vertical acceleration. The 60 m wavelength (λ) generates 0.02 g vertical acceleration at 60 mi/h, but only 0.0013 g at 15 mi/h. At the high speed, the profile should be valid for analyses that involve 200-ft wavelengths. At the low speed, the profile might be questionable for the same analysis.

λ (m)	Amp. (mm)	At 27 km/hr		At 54 km/hr		At 108 km/hr	
		Freq. (Hz)	Accel. (g)	Freq. (Hz)	Accel. (g)	Freq. (Hz)	Accel. (g)
60	20	0.13	0.0013	0.25	0.005	0.50	0.02
15	5	0.50	0.005	1.00	0.02	2.00	0.08
10 ft	0.05 in	2.50	0.025	5.00	0.10	10.00	0.40

☞ **There is a low-speed limit for inertial profilers.**

For very low speeds, the vertical acceleration is too small even for wavelengths of 15 m and shorter. The exact limit depends on two factors: (1) the use to be made of the data, and (2) the quality of the accelerometer and the instrumentation in the profilers.

As a rule of thumb, 25 km/hr should be viewed as a lower limit for obtaining profiles for “typical” analyses such as IRI. If the profiles are analyzed with mathematical transforms that involve only short wavelengths, the speed could be lowered to 15 km/hr. For analyses in which longer wavelengths are of interest, higher speeds should be used.

☞ **Using the brakes causes a small measurement error.**

Modern inertial profilers allow the speed to vary during the measurement process. The speed change is perfectly compensated if the accelerometer is oriented so (1) its axis is purely vertical, or (2) the longitudinal acceleration is zero. In fact, neither of these conditions is satisfied perfectly. As the vehicle responds to roughness in the road, it pitches forward and back, slightly, changing the vertical axis of the accelerometer relative to pure vertical. The pitch angles are small, usually being much less than one degree. However, during braking, the pitch can rise to one or two degrees. Except for braking or heavy use of the gas pedal, the longitudinal acceleration is also small.

A potential problem exists when the accelerometer is tilted and the vehicle is undergoing longitudinal acceleration, as shown in the figure below.

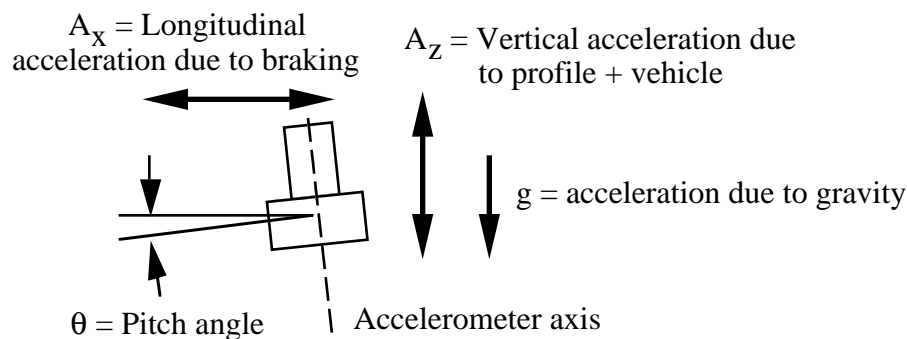

The acceleration measured by the transducer is

$$A_{\text{meas}} = (A_z - g) \cos(\theta) + A_x \sin(\theta)$$

For a 1° pitch angle, $\cos(\theta)$ is 0.99985. Even with the 1 g due to gravity, the error is just $(1 - .99985) = 0.00015$ g. The term $\sin(\theta)$ is 0.0175. Now, if there is a braking deceleration of 0.1 g, this adds an error of $(0.0175)(0.1) = 0.00175$ g. This amount of acceleration error is small enough that it will not be obvious in the profile data.

Both the longitudinal acceleration and the pitch angle are roughly proportional to braking effort. Thus, the error is roughly proportional to the braking effort squared. For example, with a 2° pitch and 0.2 g deceleration, the vertical acceleration error is 0.007 g.

 **High speeds require higher data collection rates.**

For a given sample interval, the computer and data acquisition system must sample readings from the accelerometer and height sensor at a frequency proportional to speed. Depending on the computer, the electronics, and the level of complexity in the calculations made to mathematically compute profile from the outputs of the accelerometer and height sensor, there may be a limit as to how many readings can be taken per second. At 100 km/hr (62.5 mi/hr), a profiler with two accelerometers, two height sensors, and a forward speed sensor must collect and process over 5500 readings per second to sample two profiles at a 25-mm interval.

In past years, computer processing speed has limited the sample intervals that could be handled at high speeds. With today's computer speeds, the data collection capabilities should not be a limiting factor except for very small sample intervals (smaller than an inch).

 **Speed is limited for profilers with ultrasonic sensors.**

The data collection speed for an ultrasonic sensor is limited by echoing of the acoustic ping and, to a lesser degree, the speed of sound in air. Sound travels at about 335 m/sec. Therefore, if the sensor is 150 mm above the road surface, it takes about 0.001 sec for the sound to hit the road and reflect back. At a forward speed of 100 km/hr, this means the vehicle will have traveled about 25 mm by the time the sound has been sensed. However, it takes many times that long for the echoes of the acoustic ping to die out enough to make the next reading accurately.

The exact relation between vehicle speed and the sample interval that can be achieved at that speed is determined by several factors in the design of the system. However, the clearances needed for safe operation, combined with the echoing time, combine to place a limit on sample interval for profilers with ultrasonic sensors. They typically can measure at intervals no smaller than 300 mm at highway speeds. To measure at a 150-mm interval requires lowering the measurement speed down to about 50 km/hr.

What Is the Effect of Texture?

☞ Textured surfaces cause profile measurement errors.

There are serious measurement problems posed by textured surfaces such as chip sealed or open graded pavements. The texture involves variations that occur over short distances that involve wavelengths of several inches or less. These wavelengths are outside the range of interest for most profile analyses, but they affect the performance of some instruments. The specific nature of the error depends on the type of instrument.

☞ Texture can cause alias errors.

Aliasing is illustrated with a sinusoid in the figure below.

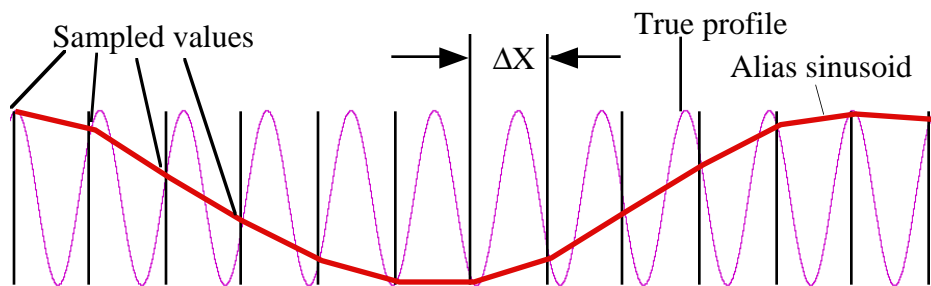

The vertical lines indicate locations where the profile is sampled, and the short-wavelength sinusoid is the example true profile being sampled. The intersections of the vertical lines and the sinusoid indicate that values that are sampled.

Recall that in order to see a sinusoid, the sample interval must be half the wavelength or smaller. The above example shows what happens when the sample interval is too large. Notice that when we connect the sampled values with straight lines, the samples seem to define a sinusoid with a much longer wavelength. This effect is called **aliasing**. The sinusoid with the long wavelength is an alias of the true sinusoid with the shorter wavelength.

Suppose the profile is being processed with an analysis that has zero response to the sinusoid in the true profile. The problem is that the analysis applied to the profile might respond to the aliased sinusoid, which has a longer wavelength. Given that the aliased sinusoid does not exist in the true profile, this is a source of error.

For profile shapes other than a sinusoid, the same effect exists. Variations in the profile cause an alias shape if the sample interval is not sufficiently small.

☞ Aliasing can be reduced for static profile measures.

Static methods such as rod and level or the Dipstick involve physical contact with the road surface. Supports that cover a very small area allow the device to sense variations that cover small distances. The foot of the Dipstick or the end of the rod fit into small depressions. On the other hand, supports with larger “footprint” areas “smooth out” the texture variations, reducing the aliasing problem.

The Dipstick has optional “moon feet” several inches in diameter, to reduce aliasing errors and texture effects. For rod and level, pads can be fabricated to increase the footprint size. For example, an attachment used in past research programs is shown below.

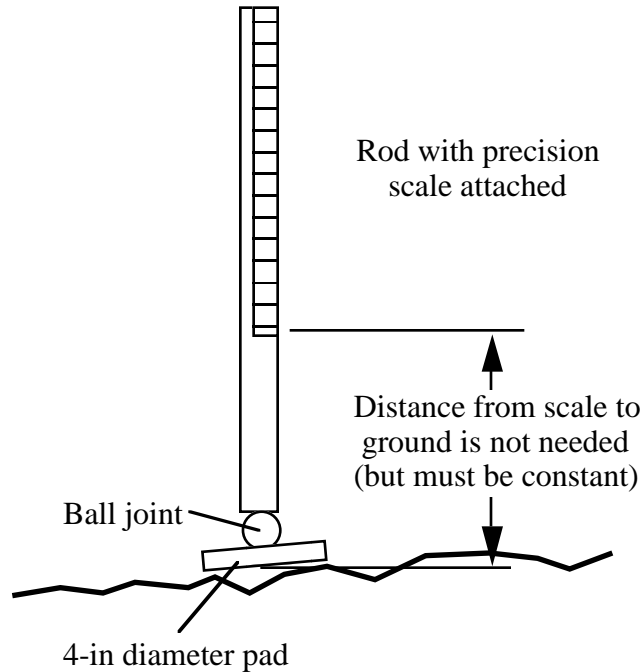

☞ **Aliasing can be reduced for laser and optical measures.**

Sensors that detect height above the road with light (laser or plain light) can be triggered at a very high rate. For example, the PRORUT system developed for Federal Highway Administration uses a laser sensor made by the Selcom company that produces a continuous output of voltage proportional to height. The laser system updates the reading 16,000 times per second. Traveling at 100 ft/sec, the samples are spaced less than 0.1 inches apart. The voltage provided by the unit as an output is filtered electronically to smooth it before it is sampled at a larger interval (e.g., 2 inches) for computer processing.

As another example, systems made by K.J. Law, Inc. compute profile at about a 1-inch interval. The computed profiles are then smoothed by a digital filter and stored at about a 6-inch interval.

The footprint of an ultrasonic sensor is large enough that aliasing is not considered a serious problem. However, textured surfaces cause serious measurement errors for ultrasonic systems for another reason.

☞ **Textured surfaces cannot be profiled with ultrasonic systems.**

Ultrasonic height sensors work by emitting a short sound pulse and listening for the returning echo. The time between the emission of the pulse and its return is proportional to the distance covered. This technique fails (1) if the surface does not

reflect the sound well enough to detect, or (2) if the surface reflects the sound many times, such that the multiple echoes confuse the sensor logic.

Experience gained over the past ten years with ultrasonic sensors repeatedly shows that they simply do not work on textured surfaces.

 **Textured surfaces cause difficulty with laser sensors.**

Laser height sensors work by projecting an image on the ground, detecting its position when viewed at an angle, and determining the distance by triangulation. This technique fails if the image cannot be detected. If the image is small relative to the scale of the texture features, it may not always be visible to the detection transducer.

Although textured surfaces cause difficulty, some instrumentation systems are designed to compensate. The laser image is monitored at a very high frequency. When the image disappears, the most recent height can be used. As soon as the image re-appears, the height is updated. Thus, a loss of the image is acceptable up to a point where it is lost nearly all of the time. The electronic logic that holds the last sample until the image re-appears is called “sample and hold.”

 **Optical and laser sensors can reduce texture problems with large images.**

Laser height sensors generally work with small dot images. Optical sensors typically project a larger image onto the ground. (Both laser and optical systems usually use infra-red light to avoid interference from visible light, and therefore, you cannot see the images without special goggles.) A larger image gives a large footprint. If the image remains visible on textured surfaces, the problems are reduced considerably.

What About Cracks?

Cracks in the pavement are usually thought of as degrading structural performance, rather than most of the performance qualities of a road that we derive from profile.

 **Cracks do not directly affect vehicle dynamics.**

Although the presence of cracks in the road implies that the road is deteriorating, and may lead to increased roughness in the future, they are not necessarily “felt” by a vehicle. This is because they are usually very narrow compared to the length of a tire contact patch.

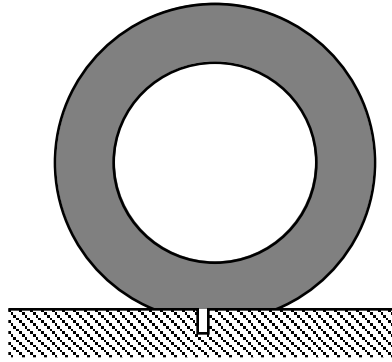

Cracks do not directly affect tires and vehicles.

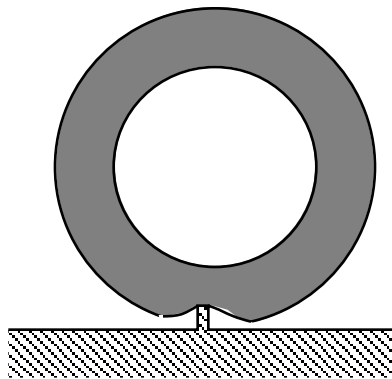

Bumps do!

☞ **Cracks do affect roughness indices.**

Laser sensors project an image onto the ground that is small enough to go into a crack. Unless a very short sample interval is used, there is not enough information to distinguish a crack from a dip with a longer duration. Systems with a close sample interval are more likely to pick up a crack, but provide enough information so that they can be identified as such. Often, however, this information is thrown away before the profile is recorded.

None of the profile analyses covered in this book include methods for handling cracks properly. They all treat a crack the same way as a bump that is as high as the crack is deep. This means that the index can be affected significantly by a road feature that is not relevant to the quality it is trying to predict.

☞ **Conventional filters do not completely remove cracks from profile.**

A low-pass filter that is applied to a profile that includes a large dip caused by a crack will reduce it, but not remove it. A special “directional” algorithm is needed that treats cracks differently than bumps. This algorithm will only be useful if the sample interval is close enough to identify a dip in the profile as a crack.

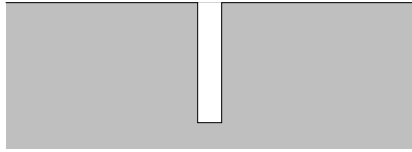

Original profile with 1" crack

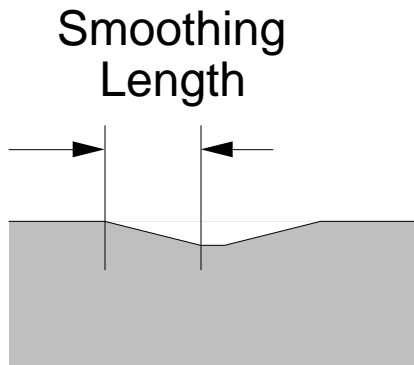

Filtered Profile (moving average)

- Feature is reduced, but not eliminated.
- Still has effect on IRI and other indices.
- “Directional Sample and Hold” algorithm is recommended

How Accurate Should a Profile Be?

There is not a single use for profiles, and there is not a single “best” profiler design for all applications.

☞ **Network monitoring requires high measurement efficiency.**

Year-to-year records of the state of a road network are used to manage sections that are typically several miles in length. Time is a significant constraint—the measurement and analysis process for the entire network must be completed in a year, when it is then time to repeat the process for the next year. Measurement speeds are typically 80 km/hr (50 mi/hr) or higher for this application.

The accuracy of individual readings is not critical, nor is the ability to pin-point trouble spots to the nearest 10 m. Recall, one of the criteria for a valid profiler is that measures are neither higher nor lower, on the average, than would be obtained with painstakingly measured “true profiles.” Random errors in measurement average out for individual sections of road and do not affect the big picture.

☞ **Diagnostic applications require accuracy and inspection of profiles.**

Time is less of a factor when the intent is to closely study sections of road of a few kilometers or less. Lower measurement speeds of 25 or 40 km/hr are acceptable. For diagnostic applications, it may be desirable to show properties of the road on a scale such that trouble spots can be located to within 10 or 20 meters. (As a point of

reference, when traveling at 100 km/hr, which is 62.5 mi/hr, you cover almost 28 meters each second. Thus, 33 meters (100 ft) corresponds to a little over 1 second of time as perceived by a driver at highway speeds.)

Accuracy may be of greater concern for diagnostic applications. The measures are not just for a statistical data base—they are to describe the exact condition of a particular section of pavement.

☞ The required profiler accuracy depends on the application.

The application of profiler data involves the analysis that will be used to process the profile, and the use to be made of the processed results.

☞ Accuracy specifications must involve sinusoidal wavelength.

Most of the analyses that are applied to profile measurements by standard computer software can be characterized meaningfully by two factors:

1. How does the analysis respond to a sinusoid with a given wavelength?
2. How significant is that wavelength in the roughness of a typical road?

Consider the first factor. Suppose the profiler is used to determine IRI roughness. It is known that when the IRI software is given a sinusoid with a wavelength longer than 100 ft, it hardly produces any output. For example, the table below shows IRI values for several sinusoids.

Wavelength	Amplitude	Slope Amplitude	IRI
60 m	20 mm	2.09 m/km	0.15 m/km
30 m	10 mm	2.09 m/km	0.62 m/km
15 m	5 mm	2.09 m/km	1.99 m/km
6 m	2 mm	2.09 m/km	1.53 m/km
3 m	1 mm	2.09 m/km	1.89 m/km
1.5 m	0.5 mm	2.09 m/km	0.99 m/km

As the wavelengths get longer, the output goes closer and closer to zero. Thus, improved accuracy in measuring profile for wavelengths over several hundred feet cannot improve the accuracy of the IRI.

Now consider the second factor: the content of the roughness in a typical road. We know from having viewed PSD functions that the variation in profile slope is approximately uniform with wave number over the range covered by the IRI. From the IRI frequency response plot, we have seen that the IRI responds more or less uniformly (within a factor of 2) to slope inputs for wavelengths longer than about 1.5 m and shorter than 24 m. A meaningful accuracy specification for a profiler optimized for obtaining IRI would specify its accuracy in measuring slope (e.g., error less than 1%, or some threshold such as 0.03 m/km) for sinusoids with wavelengths between 1.5 and 24 meters.

It is easy to evaluate the effect of profile error on the IRI, because it is linearly related to the amplitude of the sinusoid. Suppose the amplitude of the sinusoid is in error by 0.1 mm? That would cause a 10% error for the 3-m sinusoid (0.19 m/km error), a 2% error for the 15-m sinusoid (0.04 m/km), and a 0.5% error for the 60-m sinusoid (≈ 0 m/km). Clearly, a limit on elevation error alone does not tell much about accuracy for obtaining IRI.

 **A limit on slope error is appropriate for profilers used to measure IRI.**

A limit on slope error is more directly related to the final outcome. For example, suppose the error is 0.03 m/km. The IRI error would be close to 0.03 m/km for the 3-m and 15-m sinusoids, and about zero for the 60-m sinusoid.

What Is a Class 1 Profiler?

Two classes of profiling methods were defined with respect to the IRI in the guidelines published by The World Bank. (Additional classes were provided for response-type systems and subjective panel ratings.) The Class 1 and Class 2 profiler definitions were later adopted by FHWA for the HPMS data base. A recent ASTM standard, E950(94), defines four classes of profilers.

 **Classes are intended to indicate the accuracy of a profiler.**

A common verification test for a new instrument is to compare its results with those obtained from a reference. If you have two profilers, they will not give exactly the same results. Which do you use as a reference? Some profilers are clearly more accurate than others, so the concept of a Class 1 measurement was introduced in development of the IRI to define a reference to determine the accuracy of a roughness-measuring instrument and/or method. A Class 1 instrument must be so accurate that the random error is negligible: for all practical purposes, the IRI measure of a Class 1 system is the “true IRI.”

 **Class 1 originally meant IRI was usually within 2% of the truth.**

The concept of a true profile for a given line on the ground leads to the concept of a true IRI or other profile-based statistic. Using data taken in research, the level of accuracy associated with Class 1 was set at $\pm 2\%$ for 320-m (0.2-mi) test sites. (This tidbit of information was not published in the World Bank report, but is based on the recollection of the author.) Computer studies of the sensitivity of IRI to sample interval and height resolution were used to define a Class 1 profiling instrument.

The concept of Classes for profiler methods has proved popular among users and manufacturers. However, evidence from correlation studies over the past ten years indicates that current specifications of a Class 1 IRI profile measurement are not sufficient. Devices that, on paper, qualify as Class 1, do not always show the repeatability that was expected. In retrospect, the major problem is thought to be that

the specifications focus on the equipment and not its use. Some of the error sources mentioned in the previous section exist no matter how accurate a profiler is.

Existing Class 1 definitions are not sufficient.

Evidence of the problem is obtained when studies are done where different instruments profile the same sites to obtain IRI measures. For example, the figure below shows repeated measures from six devices that, on paper, qualify as Class 1 devices.

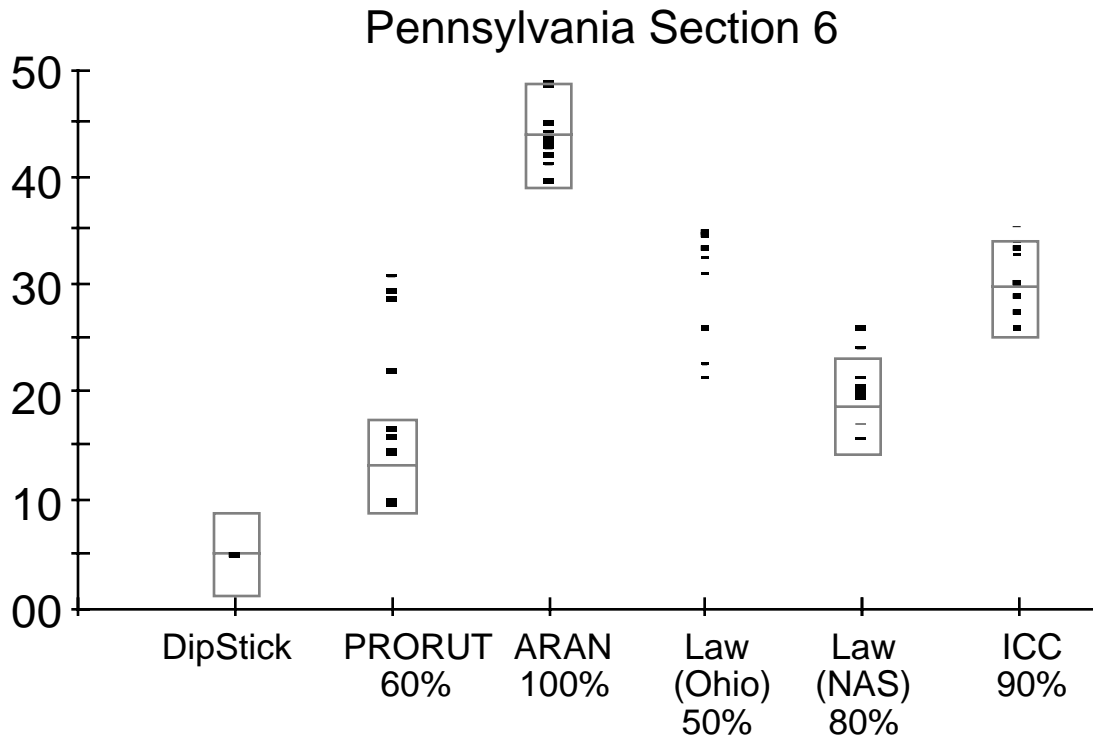

The plot shows data from taken from 1993 correlation data collected for a study initiated by RPUG. In the study, considerable effort was taken to ensure that profiles all began at the same longitudinal location. The boxes in the figure show $\pm 2\%$ range. The plot shows two interesting results:

1. The repeatability for some of the instruments is not within 2%, however, the repeatability is generally pretty good.
2. The total range covers 205 to 247 in/mi, which is approximately a 20% variation.

There are limitations with the equipment that are not covered by the specification of sample interval and height resolution. Experience now shows that a device might have trouble with a specific road surface. A common example is that certain textured surfaces can confuse even the best non-contacting height sensors used in high-speed profilers. Another example is that the Dipstick can miss significant roughness on a surface with bumps shorter than its 12-in base length.

As experience is gained, areas emerge where differences between instruments are not easily explained. For example, it was shown earlier that profiles change significantly due to temperature and seasonal variations. Provisions must be made to account for this effect in the acquisition of profile data for research involving Class 1 methods.

 **Research is needed to refine the definition of a Class 1 measurement.**

As a minimum, the specification should be extended to describe a test method for using the instrument that allows the user to estimate its quality (e.g., by looking at the scatter in repeated measures).

Bibliography

Interpretation of Road Roughness

Sayers, M.W. and S.M. Karamihas, *Interpretation of Road Roughness Profile Data*. Federal Highway Administration Report FHWA/RD-96/101, (1996) 177 p.

The International Roughness Index

Sayers, M.W., "On the Calculation of International Roughness Index from Longitudinal Road Profile." *Transportation Research Record 1501*, (1995) pp. 1-12.

Sayers, M.W., et al., *Guidelines for Conducting and Calibrating Road Roughness Measurements*. World Bank Technical Paper Number 46, (1986) 87 p.

Ride Number

Janoff, M.S., *Pavement Roughness and Rideability Field Evaluation*. National Cooperative Highway Research Program Report 308, (1988) 54 p.

Janoff, M.S., et al., *Pavement Roughness and Rideability*. National Cooperative Highway Research Program Report 275, (1985) 69 p.

Sayers, M.W. and S.M. Karamihas, "Estimation of Rideability by analyzing Longitudinal Road Profile." *Transportation Research Record 1536*, (1996) pp. 110-116.

Spangler, E.B. and W.J. Kelly, "Development and Evaluation of the Ride Number Concept," *Vehicle-Road Interaction, ASTM STP 1225*, B. T. Kulakowski ed., American Society of Testing and Materials, Philadelphia, (1994) pp. 135-149.

Panel Ratings

Hutchinson, B.G., "Principles of Subjective Rating Scale Construction." *Highway Research Record 46*, (1964) pp. 60-70.

Loizos, A., et al., "Effects of User Characteristics and Vehicle Type on Road Roughness Perception." *Road and Transport Research Vol. 3, No. 4*, (1994) pp. 57-65.

Nick, J.B. and M.S. Janoff, "Evaluation of Panel Rating Methods for Assessing Pavement Ride Quality." *Transportation Research Record 946*, (1983) pp. 5-13.

Weaver, R.J., "Quantifying Pavement Serviceability as It Is Judged by Highway Users." *Transportation Research Record 715*, (1979) pp. 37-44.

Half-Car Roughness Index

Sayers, M.W., "Two Quarter-Car Models for Defining Road Roughness: IRI and HRI." *Transportation Research Record 1215*, (1989) pp. 165-172.

Root Mean Squared Vertical Acceleration

Hudson, W.R., et al., "Root-Mean-Square Vertical Acceleration as a Summary Roughness Statistic," *Measuring Road Roughness and Its Effects on User Cost and Comfort, ASTM STP 884*, T. D. Gillespie and M. W. Sayers ed., American Society of Testing and Materials, Philadelphia, (1985) pp. 3-24.

Michigan Ride Quality Index

Darlington, J., *A Roughness Wavelength Band Determined by Subjective Response*. Michigan Department of State Highways unpublished report, (1976) 6 p.

Pavement Serviceability

The AASHO Road Test, Report 5, Pavement Research. Highway Research Board Special Report 61E, (1962) 352 p.

Carey, W.N. and P.E. Irick, "The Pavement Serviceability-Performance Concept." *Highway Research Board Bulletin 250*, (1960) pp. 40-58.

Response-Type Road Roughness Measuring Systems

Gillespie, T.D., et al., *Calibration of Response-Type Road Roughness Measuring Systems*. National Cooperative Highway Research Program Report 228, (1980) 81 p.

Hveem, F.N., "Devices for Recording and Evaluating Pavement Roughness." *Highway Research Board Bulletin 264*, (1960) pp. 1-26.

Profiling Methods

"Standard Test Method for Measuring Longitudinal Profile of Traveled Surfaces with an Accelerometer Established Inertial Profiling Reference." *Annual Book of ASTM Standards Vol. 04.03, E950*, (1996) pp. 702-706.

"Standard Test Method for Measuring Road Roughness by Static Rod and Level Method." *Annual Book of ASTM Standards Vol. 04.03, E1364*, (1996) pp. 750-755.

Gillespie, T.D., et al., *Methodology for Road Roughness Profiling and Rut Depth Measurement*. Federal Highway Administration Report FHWA/RD-87-042, (1987) 50 p.

Huft, D.L., "South Dakota Profilometer." *Transportation Research Record 1000*, (1984) pp. 1-7.

Spangler, E.B. and W.J. Kelly, "GMR Road Profilometer - A Method for Measuring Road Profile." *Highway Research Record 121*, (1966) pp. 27-54.

Vehicle Dynamics

Gillespie, T.D., *Fundamental of Vehicle Dynamics*. Society of Automotive Engineers, Warrendale, PA (1992) 495 p.

Truck Ride

Gillespie, T.D., *Heavy Truck Ride*. Society of Automotive Engineers SP-607, (1985) 66 p.

Truck Wheel Loads

Ervin, R.D., et al., Influence of Truck Size and Weight Variables on the Stability and Control Properties of Heavy Trucks. Federal Highway Administration Report FHWA-RD-83-030, (1983) 179 p.

Sweatman, P.F., *Study of Dynamic Wheel forces in Axle Group Suspensions of Heavy Vehicles*. Australian Road Research Board Special Report 27, (1983) 56 p.

Whittemore, A.P., et al., *Dynamic Pavement Loads of Heavy Highway Vehicles*. National Cooperative Highway Research Program Report 105, (1970) 94 p.